



Aerodynamics

R. Tognaccini

Introduction

Hydrostatics

Fundamental principles

Incompressible inviscid flow

Effects of viscosity

Effects of compressibility

Aircraft lift-drag polar

An introduction to Aerodynamics

Renato Tognaccini¹

*Dipartimento di Ingegneria Industriale,
Università di Napoli Federico II*

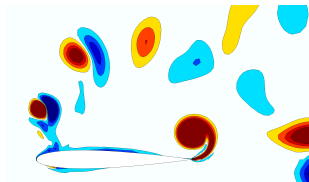
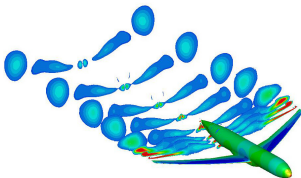



Some definitions

Aerodynamics

R. Tognaccini

Introduction

Hydrostatics

Fundamental principles

Incompressible inviscid flow

Effects of viscosity

Effects of compressibility

Aircraft lift-drag polar

Fluid a substance without its own shape; characterized by its own volume (**liquid**) or by the volume of the container (**gas**).

Continuum each part of the fluid, whatever small, contains a very large (infinite) number of molecules.

Fluid particle an infinitely small volume in the (macroscopic) scale of our interest, but sufficiently large in the (microscopic) length scale of molecules in order to contain an infinite number of molecules.

Aerodynamics branch of **Fluid Mechanics** concentrating on the interaction between a moving body and the fluid in which it is immersed.



The aerodynamic forces

Aerodynamics

R. Tognaccini

Introduction

Hydrostatics

Fundamental principles

Incompressible inviscid flow

Effects of viscosity

Effects of compressibility

Aircraft lift-drag polar

$O(x, y, z)$ inertial reference system fixed to the aircraft.

V_∞ aircraft speed at flight altitude h characterized by pressure p_∞ and density ρ_∞ .

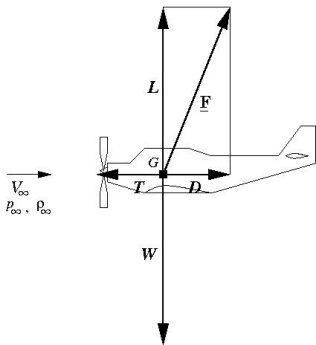

Dynamic equilibrium

$$L = W \quad T = D \quad (1)$$

L lift $\perp V_\infty$

D drag $\parallel V_\infty$

W aircraft weight^a

T thrust

^aG is the center of gravity



The aerodynamic force coefficients

Aerodynamics

R. Tognaccini

Introduction

Hydrostatics

Fundamental principles

Incompressible inviscid flow

Effects of viscosity

Effects of compressibility

Aircraft lift-drag polar

$\frac{1}{2}\rho_{\infty} V_{\infty}^2 S$ reference force

S reference surface (usually wing surface S_w)

Lift and drag coefficients

$$C_L = \frac{L}{\frac{1}{2}\rho_{\infty} V_{\infty}^2 S} \quad C_D = \frac{D}{\frac{1}{2}\rho_{\infty} V_{\infty}^2 S} \quad (2)$$

Aerodynamic efficiency

$$E = \frac{L}{D} = \frac{C_L}{C_D} \quad (3)$$



Practical applications

Aerodynamics

R. Tognaccini

Introduction

Hydrostatics

Fundamental principles

Incompressible inviscid flow

Effects of viscosity

Effects of compressibility

Aircraft lift-drag polar

Problem n. 1

Compute lift coefficient of an aircraft in uniform horizontal flight:

$$C_L = \frac{1}{\frac{1}{2}\rho_\infty V_\infty^2} \frac{W}{S} \quad (4)$$

Problem n. 2

Compute stall speed of an aircraft in uniform horizontal flight:

$$V_s = \sqrt{\frac{1}{C_{L_{max}}}} \sqrt{\frac{W}{S}} \sqrt{\frac{2}{\rho_\infty}} \quad (5)$$



Fundamental flow parameters

Mach number

Aerodynamics

R. Tognaccini

Introduction

Hydrostatics

Fundamental principles

Incompressible inviscid flow

Effects of viscosity

Effects of compressibility

Aircraft lift-drag polar

Mach number definition

$$M = \frac{V}{a} \quad (6)$$

V : fluid particle velocity, a : local sound speed

- A flow with constant density everywhere is called **incompressible**.
- Liquids are incompressible.
- In an incompressible flow $M = 0$ everywhere.
- In some circumstances compressible fluids (gas) behave as incompressible (liquid): $M \rightarrow 0$.



Fundamental flow parameters

Reynolds number

1/2

Aerodynamics

R. Tognaccini

Introduction

Hydrostatics

Fundamental principles

Incompressible inviscid flow

Effects of viscosity

Effects of compressibility

Aircraft lift-drag polar

Reynolds number definition

$$Re = \frac{\rho V L}{\mu} \quad (7)$$

L : reference length,

μ : dynamic viscosity ($\frac{Kg}{ms}$)

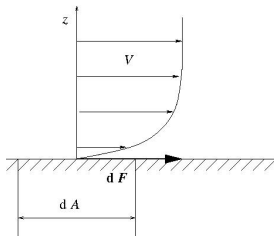

A fluid flowing on a solid plate.

Newtonian fluid

$$dF = \mu \frac{\partial v}{\partial z} dA \quad (8)$$

- Friction proportional to velocity gradient in the flow.



Fundamental flow parameters

Reynolds number

2/2

Aerodynamics

R. Tognaccini

Introduction

Hydrostatics

Fundamental principles

Incompressible inviscid flow

Effects of viscosity

Effects of compressibility

Aircraft lift-drag polar

- The Reynolds number compares dynamic forces (associated with momentum of fluid particles) against friction forces (associated with momentum of molecules).
- A flow in which $\mu = 0$ is named **inviscid** or **not dissipative**.
- In an inviscid flow $Re = \infty$ and friction can be neglected.

kinematic viscosity:

$$\nu = \frac{\mu}{\rho} \quad \left(\frac{m^2}{s} \right) \quad (9)$$

- For air in standard conditions: $\nu \approx 10^{-5} \frac{m^2}{s}$.
- In Aeronautics usually $Re \gg 1$: in many aspects (**but not all**) the flow behaves as inviscid.



Flow regimes

Aerodynamics

R. Tognaccini

Introduction

Hydrostatics

Fundamental principles

Incompressible inviscid flow

Effects of viscosity

Effects of compressibility

Aircraft lift-drag polar

Based on Mach number:

$M = 0$ (everywhere) incompressible flow

$M \ll 1$ (everywhere) incompressible flow

$M < 1$ (everywhere) subsonic flow

$M < 1$ and $M > 1$ transonic flow

$M > 1$ (everywhere) supersonic flow

$M \gg 1$ hypersonic flow

Based on Reynolds number:

$Re \rightarrow 0$ Stokes (or creeping) flow

$Re \rightarrow \infty$ ideal flow



Critical Mach numbers

Aerodynamics

R. Tognaccini

Introduction

Hydrostatics

Fundamental principles

Incompressible inviscid flow

Effects of viscosity

Effects of compressibility

Aircraft lift-drag polar

$M'_{\infty,cr}$ **lower critical Mach number**: freestream Mach number producing at least one point in which $M = 1$ whereas elsewhere $M < 1$

$M''_{\infty,cr}$ **upper critical Mach number**: freestream Mach number producing at least one point in which $M = 1$ whereas elsewhere $M > 1$

$M_{\infty} < M'_{\infty,cr}$ subsonic regime

$M'_{\infty,cr} < M_{\infty} < M''_{\infty,cr}$ transonic regime

$M_{\infty} > M''_{\infty,cr}$ supersonic regime



Practical applications

Aerodynamics

R. Tognaccini

Introduction

Hydrostatics

Fundamental principles

Incompressible inviscid flow

Effects of viscosity

Effects of compressibility

Aircraft lift-drag polar

Problem n. 3

Compute freestream Mach number of a given aircraft:

$$M_{\infty} = \frac{V_{\infty}}{a_{\infty}} \quad (10)$$

$$a_{\infty} = \sqrt{\gamma RT_{\infty}}, \quad \gamma = 1.4, \quad R = 287 \text{ J}/(\text{KgK}), \quad T_{\infty} = 272 \text{ K}$$

(at sea level)

Problem n. 4

Compute freestream Reynolds number for a given aircraft:

$$Re_{\infty} = \frac{V_{\infty} L}{\nu_{\infty}} \quad (11)$$



Genesis of lift

Aerodynamics

R. Tognaccini

Introduction

Hydrostatics

Fundamental principles

Incompressible inviscid flow

Effects of viscosity

Effects of compressibility

Aircraft lift-drag polar

Newton's second law $\underline{F} = m\underline{a}$

\underline{F} : force, m : mass, \underline{a} : acceleration

Newton's third law for every action, there is an equal and opposite reaction

Newton's second law for an aircraft in horizontal flight:

$$L = \dot{m}\Delta V \qquad \frac{\Delta V}{V_\infty} = \frac{2C_L}{e\pi\mathcal{R}} \qquad (12)$$

\dot{m} mass flow rate of air interacting with aircraft

$\dot{m} = e\rho_\infty V_\infty \pi b^2/4$ where b is the wing span and $e \approx 1$

ΔV **downwash**, vertical component of air speed after interaction with aircraft

\mathcal{R} **wing aspect ratio** $\mathcal{R} = b^2/S_w$



Genesis of (lift) induced drag D_i

Aerodynamics

R. Tognaccini

Introduction

Hydrostatics

Fundamental principles

Incompressible inviscid flow

Effects of viscosity

Effects of compressibility

Aircraft lift-drag polar

Kinetic energy variation of the air flow interacting with aircraft:

$$\Delta E = \frac{1}{2} \dot{m} [V_\infty^2 + \Delta V^2 - V_\infty^2] = \frac{1}{2} \dot{m} \Delta V^2 \quad (13)$$

Due to the **law of energy conservation** the aircraft is making work on the fluid, the only possibility is the presence of a **drag** force $\parallel V_\infty$:

$$D_i V_\infty = \Delta E \quad (14)$$

Due to definition of C_D and downwash formula:

$$C_{D_i} = \frac{C_L^2}{e\pi AR} \quad (15)$$

e Oswald factor ($e \leq 1$)

$e = 1$ **elliptic wing**: elliptic chord distribution with fixed airfoil and no twist



Drag of an aircraft

Aerodynamics

R. Tognaccini

Introduction

Hydrostatics

Fundamental principles

Incompressible inviscid flow

Effects of viscosity

Effects of compressibility

Aircraft lift-drag polar

$$D = D_i + D_p + D_w \quad (16)$$

D_p **profile drag**: associated with the direct action of viscosity
 D_w **wave drag**: it appears in transonic and supersonic regimes.

Lift-drag polar

$$C_L = C_L(C_D, Re_\infty, M_\infty, \dots) \quad (17)$$

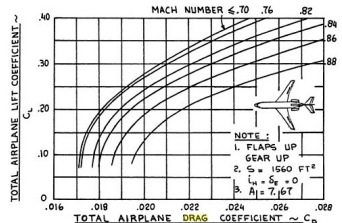



Practical applications

Aerodynamics

R. Tognaccini

Introduction

Hydrostatics

Fundamental
principles

Incompressible
inviscid flow

Effects of
viscosity

Effects of
compressibility

Aircraft
lift-drag polar

Problem n. 5

Compute and compare lift induced drag of an aircraft in cruise and landing

- What is the value of e ?
- Warning: drag coefficient is not equivalent to drag



Wing geometry

Aerodynamics

R. Tognaccini

Introduction

Hydrostatics

Fundamental principles

Incompressible inviscid flow

Effects of viscosity

Effects of compressibility

Aircraft lift-drag polar

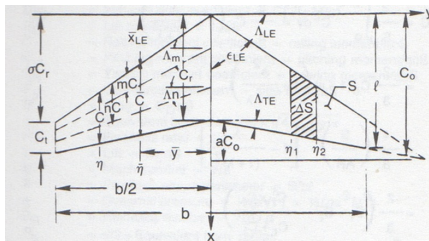

$$\eta = \frac{y}{b/2}$$

$$\lambda = \frac{c_t}{c_r}$$

$$c = c_r[1 - \eta(1 - \lambda)], \text{ chord distribution}$$

$$\bar{c} = \frac{2}{S} \int_0^{b/2} c^2(y) dy, \text{ mean aerodynamic chord (M.A.C.)}$$

α = Angle of Attack

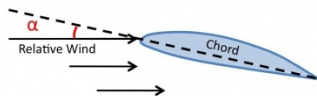

α defined at wing root

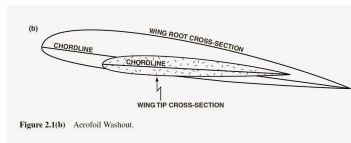

Figure 2.1(b) Aerofoil Washout.

ϵ_g twist: angle between tip and root chords



The airfoil

Aerodynamics

R. Tognaccini

Introduction

Hydrostatics

Fundamental principles

Incompressible inviscid flow

Effects of viscosity

Effects of compressibility

Aircraft lift-drag polar

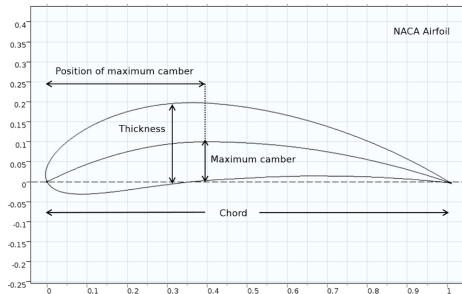

$\tau = \text{thickness} / \text{chord}$, airfoil percentage thickness

- Assuming a rectangular wing of infinite \mathcal{R} , the flow is two-dimensional, i.e. flow variables do not change in planes parallel to the symmetry plane of the wing.
- We can just study a two-dimensional flow around the airfoil.



Airfoil aerodynamic characteristics

Aerodynamics

R. Tognaccini

Introduction

Hydrostatics

Fundamental principles

Incompressible inviscid flow

Effects of viscosity

Effects of compressibility

Aircraft lift-drag polar

$$\text{Lift } l = C_l \frac{1}{2} \rho_{\infty} V_{\infty}^2 c$$

$$\text{Drag } d = C_d \frac{1}{2} \rho_{\infty} V_{\infty}^2 c$$

$$\text{Pitching moment } m_{le} = C_{m_{le}} \frac{1}{2} \rho_{\infty} V_{\infty}^2 c^2$$

■ referenced to airfoil leading edge

- For airfoils, force and moments are intended per unit length.
- $m_{le}, C_{m_{le}} > 0$ in case of pull up.
- Alternatively, pitching moment can be referenced to quarter chord point ($m_{1/4}, C_{m_{1/4}}$)



Lift and polar curve of an airfoil in ipersonic flow ($M_\infty \ll 1$)

Aerodynamics

R. Tognaccini

Introduction

Hydrostatics

Fundamental
principles

Incompressible
inviscid flow

Effects of
viscosity

Effects of
compressibility

Aircraft
lift-drag polar

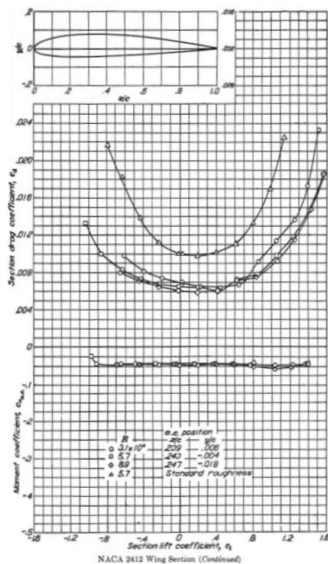
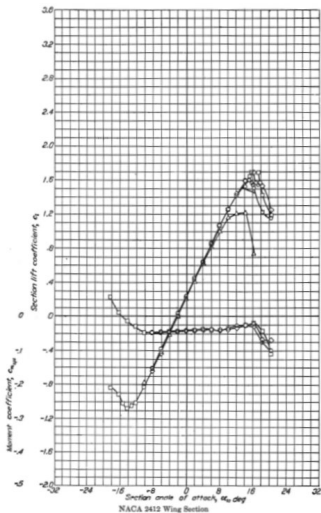



Some remarks on airfoil performance in iposonic flow ($M_\infty \ll 1$)

Aerodynamics

R. Tognaccini

Introduction

Hydrostatics

Fundamental
principles

Incompressible
inviscid flow

Effects of
viscosity

Effects of
compressibility

Aircraft
lift-drag polar

There is a (small) range of α in which:

Iposonic flow:

$$C_l = C_{l\alpha}(\alpha - \alpha_{zI}) \quad (18)$$

The lift curve is a straight line.

- $C_{l\alpha} \approx 2\pi$ is the lift curve slope and α_{zI} is the zero lift angle.
- At larger α evidenced the stall phenomenon, characterized by the maximum lift coefficient ($C_{l_{max}}$) and the corresponding stall angle α_s .
- Airfoil efficiency is very large (> 100) at small α , but drag very significantly grows near stall and beyond.



Some remarks on airfoil performance in supersonic flow ($M > 1$ everywhere)

Aerodynamics

R. Tognaccini

Introduction

Hydrostatics

Fundamental
principles

Incompressible
inviscid flow

Effects of
viscosity

Effects of
compressibility

Aircraft
lift-drag polar

In the case of a thin airfoil at small α :

Lift:

$$C_l \approx \frac{4\alpha}{\sqrt{M_\infty^2 - 1}} \quad (19)$$

Wave drag:

$$C_{dw} \approx \frac{4\alpha^2}{\sqrt{M_\infty^2 - 1}} \quad (20)$$

- Dramatic differences between subsonic and supersonic flow!



Wing performance in ipersonic flow

Aerodynamics

R. Tognaccini

Introduction

Hydrostatics

Fundamental
principles

Incompressible
inviscid flow

Effects of
viscosity

Effects of
compressibility

Aircraft
lift-drag polar

Case of $\mathcal{R} \gg 1$:

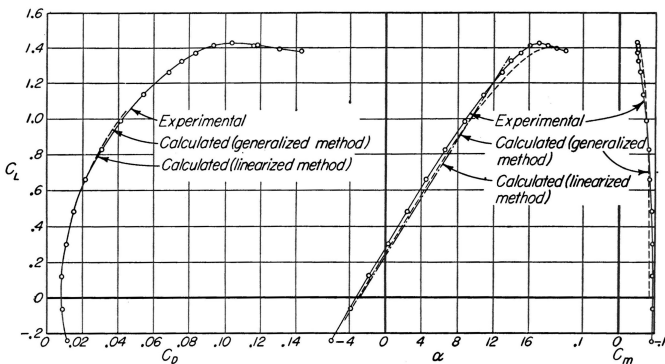

Trapezoidal wing, $\mathcal{R} = 10$, $M_\infty \ll 1$, $Re_\infty \gg 1$.



Some remarks on wing performance in ipersonic flow

Aerodynamics

R. Tognaccini

Introduction

Hydrostatics

Fundamental
principles

Incompressible
inviscid flow

Effects of
viscosity

Effects of
compressibility

Aircraft
lift-drag polar

At small α :

$$C_L = C_{L\alpha}(\alpha - \alpha_{zL}) \quad (21)$$

The lift curve is still a straight line.

- $\mathcal{R} \gg 1$: $C_{L\alpha} \approx \frac{C_{l\alpha}}{1 + \frac{C_{l\alpha}}{\pi \mathcal{R}}}$
- $\mathcal{R} < 1$: $C_{L\alpha} \approx \frac{\pi}{2} \mathcal{R}$
- Lift grows slower against α on the wing respect to the airfoil.
- Completely different Aerodynamics of combat aircraft wings (small \mathcal{R}) against transport aircraft wings (large \mathcal{R}).



Hydrostatics

Aerodynamics

R. Tognaccini

Introduction

Hydrostatics

Fundamental principles

Incompressible inviscid flow

Effects of viscosity

Effects of compressibility

Aircraft lift-drag polar

We assume the fluid occupies an infinite space where $\underline{V} = 0$ everywhere.

ΔS elementary fluid surface.

\underline{n} unit vector $\perp \Delta S$ identifying ΔS .

ΔF module of the force acting on ΔS , due to the molecular momentum exchange across ΔS .

Definition of hydrostatic pressure

$$p = \lim_{\Delta S \rightarrow 0} \frac{\Delta F}{\Delta S} \quad p > 0 \quad (22)$$

Pascal's principle

$$d\underline{F} = -p\underline{n}dS \quad (23)$$

In a fluid at rest ΔF is orthogonal to ΔS .





Stevino's law

Aerodynamics

R. Tognaccini

Introduction

Hydrostatics

Fundamental principles

Incompressible inviscid flow

Effects of viscosity

Effects of compressibility

Aircraft lift-drag polar

We consider an infinitesimal volume $dx dy dz$ of fluid at rest. z is a vertical axis bottom-top oriented and specifies altitude.

z -component of total pressure force:

$$p \, dx dy - (p + dp) \, dx dy = -\frac{dp}{dz} dx dy dz \quad (24)$$

Equilibrium between gravity and pressure forces ($g = 9.81 m/s^2$ is gravitational acceleration):

$$p = p(z) \quad , \quad -\frac{dp}{dz} dx dy dz - \rho g dx dy dz = 0 \quad (25)$$

Stevino's law

$$dp = -\rho g dz \quad (26)$$

For a liquid ($\rho = \text{const}$):

$$p(z_2) - p(z_1) = -\rho g (z_2 - z_1) \quad (27)$$





Some applications of Stevino's law

Aerodynamics

R. Tognaccini

Introduction

Hydrostatics

Fundamental principles

Incompressible inviscid flow

Effects of viscosity

Effects of compressibility

Aircraft lift-drag polar

A straightforward consequence is:

Archimedes' principle

The buoyant force that is exerted on a body immersed in a fluid is equal to the weight of the fluid that the body displaces and acts in the upward direction at the center of mass of the displaced fluid.

Simple device for measuring pressure:
Torricelli's barometer

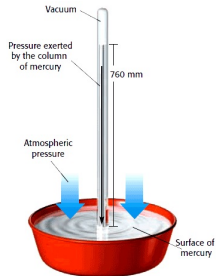



International Standard Atmosphere (ISA)

Aerodynamics

R. Tognaccini

Introduction

Hydrostatics

Fundamental principles

Incompressible inviscid flow

Effects of viscosity

Effects of compressibility

Aircraft lift-drag polar

Assumptions

- The air is dry.
- The air is a perfect gas:

$$p = \rho RT \quad (28)$$

- The air is at rest and Stevino's law is valid:

$$dp = -\rho g dz$$

$$T_{SL} = 288K, \rho_{SL} = 1.23Kg/m^3, p_{SL} = 101000Pa$$

$$0 < z \leq 11Km: \text{ troposphere, } T_z = -6.5K/Km$$

$$11 < z \leq 25Km: \text{ stratosphere, } T_z = 0$$

$$25 < z \leq 47Km: \text{ mesosphere, } T_z = 3K/Km$$

T_z : temperature gradient.

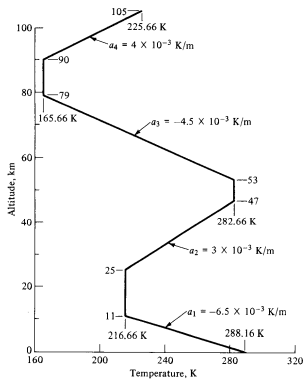



Application: compute $\rho(z)$ and $p(z)$ in the troposphere

Aerodynamics

R. Tognaccini

Introduction

Hydrostatics

Fundamental principles

Incompressible inviscid flow

Effects of viscosity

Effects of compressibility

Aircraft lift-drag polar

Dividing Stevino's law and perfect gas equation:

$$\frac{dp}{p} = -\frac{g}{R} \frac{dz}{T(z)} \Rightarrow \int_{p_{SL}}^p \frac{d\bar{p}}{\bar{p}} = -\frac{g}{R} \int_0^z \frac{d\bar{z}}{T(\bar{z})} \quad (29)$$

In the troposphere: $T = T_{SL} - T_z z$ and the integral can be solved:

$$\frac{p}{p_{SL}} = \left(\frac{T}{T_{SL}} \right)^{\frac{g}{RT_z}} \quad (30)$$

By perfect gas equation:

$$\frac{\rho}{\rho_{SL}} = \left(\frac{T}{T_{SL}} \right)^{\frac{g}{RT_z} - 1} \quad (31)$$



Fluid particle kinematics

Some definitions

Aerodynamics

R. Tognaccini

Introduction

Hydrostatics

Fundamental principles

Incompressible inviscid flow

Effects of viscosity

Effects of compressibility

Aircraft lift-drag polar

Trajectory (or particle path), the curve traced out by a particle as time progresses.

Streamline for a fixed time is a curve in space tangent to particle velocities in each point.

Strakeline the locus of all fluid particles which, at some time have past through a particular point.

In steady flow, trajectories, streamlines and strakelines are coincident.



Streamlines and strakelines

Aerodynamics

R. Tognaccini

Introduction

Hydrostatics

Fundamental principles

Incompressible inviscid flow

Effects of viscosity

Effects of compressibility

Aircraft lift-drag polar

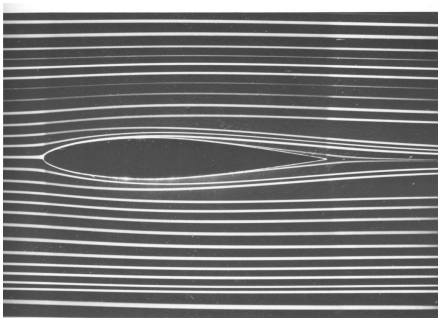

Streamline visualization around a NACA airfoil,

$$M_\infty \approx 0, Re_\infty \approx 6000.$$

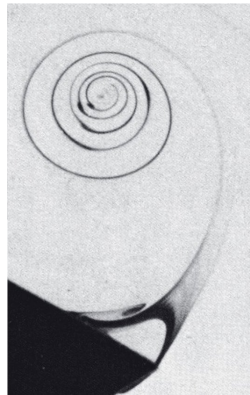

Streakline visualization around a wedge.



Motion of a fluid particle

Aerodynamics

R. Tognaccini

Introduction

Hydrostatics

Fundamental principles

Incompressible inviscid flow

Effects of viscosity

Effects of compressibility

Aircraft lift-drag polar

- A fluid particle **translates** (with velocity \underline{V}) **rotates** (with angular velocity $\underline{\Omega}$) and **deforms** (volume and shape change).
- Rotation and deformation can be computed by performing spatial partial derivatives of the velocity field $\underline{V}(x, y, z) = (V_x, V_y, V_z)$.

Vorticity $\underline{\omega} = 2\underline{\Omega}$, fluid property linked to angular velocity of fluid particle ².

Dilatation Θ , percentage variation of the volume of a fluid particle in the unit time ³.

In incompressible flow ($\rho = \text{const}$) $\Theta = 0$.

$${}^2 \underline{\omega} = \left(\frac{\partial V_y}{\partial x} - \frac{\partial V_x}{\partial y}, -\frac{\partial V_z}{\partial x} + \frac{\partial V_x}{\partial z}, \frac{\partial V_z}{\partial x} - \frac{\partial V_x}{\partial y} \right)$$

$${}^3 \Theta = \frac{\partial V_x}{\partial x} + \frac{\partial V_y}{\partial y} + \frac{\partial V_z}{\partial z}$$



Conservation of mass (continuity equation)

Aerodynamics

R. Tognaccini

Introduction

Hydrostatics

Fundamental principles

Incompressible inviscid flow

Effects of viscosity

Effects of compressibility

Aircraft lift-drag polar

Mass can be neither created nor destroyed.

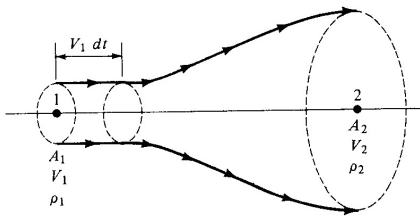

Mass contained in the volume

$A_1 V_1 dt$:

$dm_1 = \rho_1 A_1 V_1 dt$.

At time t_2 :

$dm_2 = \rho_2 A_2 V_2 dt$.

The principle of mass conservation ensures that:

$dm_2 = dm_1$.

Continuity equation:

$$\rho_1 V_1 A_1 = \rho_2 V_2 A_2 \quad (32)$$

$$\text{mass flow } \dot{m} \equiv \frac{dm}{dt} = \rho VA$$

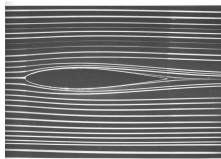

Between two streamlines

$\dot{m} = \text{const}$



Conservation of mass in incompressible flow ($\rho = \text{const}$)

Aerodynamics

R. Tognaccini

Introduction

Hydrostatics

Fundamental
principles

Incompressible
inviscid flow

Effects of
viscosity

Effects of
compressibility

Aircraft
lift-drag polar

Continuity equation:

$$V_1 A_1 = V_2 A_2 \quad (33) \quad \text{If } \dot{m} \text{ and } A(x) \text{ are known:}$$

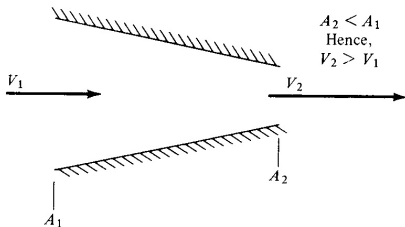

$$V = \frac{\dot{m}}{\rho A} \quad (34)$$

velocity is known in each
section!

- Velocity increases along a convergent channel.
- Velocity decreases along a divergent channel.

Quasi-1d flow

- Channel with small variations of section area $A(x)$.
- Unknowns are *average* quantities in each section.

**Warning: the behavior is
opposite in supersonic flow!**



Momentum equation (1/2)

Aerodynamics

R. Tognaccini

Introduction

Hydrostatics

Fundamental principles

Incompressible inviscid flow

Effects of viscosity

Effects of compressibility

Aircraft lift-drag polar

Momentum equation is second law of Dynamics $\underline{F} = m\underline{a}$ specialized for a fluid particle P .

Forces acting on P :

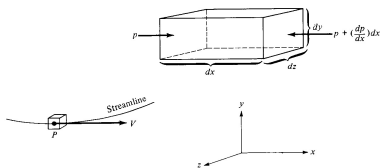

- particle weight $dm \underline{g}$;
- pressure acting orthogonal to each particle face;
- friction force acting tangent to each particle face.

Hypotheses:

- negligible friction force ($\mu = 0$);
- negligible effects of gravity

Total force acting on the fluid particle P in streamwise direction:

$$F = p dy dz - \left(p + \frac{dp}{dx} dx \right) dy dz = - \frac{dp}{dx} dx dy dz$$



Momentum equation (2/2)

Aerodynamics

R. Tognaccini

Introduction

Hydrostatics

Fundamental principles

Incompressible inviscid flow

Effects of viscosity

Effects of compressibility

Aircraft lift-drag polar

Fluid particle mass and acceleration:

$$dm = \rho dx dy dz; \quad a = \frac{dV}{dt} = \frac{dV}{dx} \frac{dx}{dt} = \frac{dV}{dx} V.$$

Momentum equation

$$\frac{dp}{dx} + \rho V \frac{dV}{dx} = 0 \quad (35)$$

Conservation + momentum equations in inviscid flow are called **Euler equations**.



Bernoulli's theorem

in inviscid and **incompressible** flow

Aerodynamics

R. Tognaccini

Introduction

Hydrostatics

Fundamental principles

Incompressible inviscid flow

Effects of viscosity

Effects of compressibility

Aircraft lift-drag polar

If $\rho = \text{const}$ eq. (35) can be easily integrated along a streamline:

$$\int_{p_1}^{p_2} dp + \rho \int_{V_1}^{V_2} V dV = 0 \quad (36)$$

obtaining:

Bernoulli's equation

$$p + \frac{1}{2}\rho V^2 = \text{const} \quad (37)$$

In the case of a body immersed in an uniform stream, the constant is the same everywhere:

$$p + \frac{1}{2}\rho V^2 = p_\infty + \frac{1}{2}\rho V_\infty^2 \quad (38)$$



Some remarks on Bernoulli's theorem

Aerodynamics

R. Tognaccini

Introduction

Hydrostatics

Fundamental principles

Incompressible inviscid flow

Effects of viscosity

Effects of compressibility

Aircraft lift-drag polar

- It holds along a streamline for a **steady**, **inviscid** (frictionless) and **incompressible** flow.
- $q = \rho V^2/2$ is named **dynamic pressure**.
- Standard pressure p is often named **static pressure**.
- $p_0 = p + \rho V^2/2$ is named **total** or **stagnation** pressure.
- The stagnation pressure (p_0) is the pressure of a fluid particle when decelerate to $\underline{V} = 0$ in an adiabatic and frictionless process.
- In an incompressible, steady, inviscid quasi-1d flow (channel) V and p can be computed by continuity and Bernoulli's equations provided the flow is known in one point of the channel.



Energy equation (1/3)

Aerodynamics

R. Tognaccini

Introduction

Hydrostatics

Fundamental principles

Incompressible inviscid flow

Effects of viscosity

Effects of compressibility

Aircraft lift-drag polar

Energy can be neither created nor destroyed,
it can only change form.

It is nothing more than the first law of Thermodynamics for a Thermodynamic system:

$$\delta q + \delta w = de \quad (39)$$

δq heat flux entering the system (per unit mass),

δw work done by the system (per unit mass),

e internal energy per unit mass. ⁴

⁴For a perfect gas $e = C_v T$, where C_v is the specific heat at constant volume.



Energy equation (2/3)

Aerodynamics

R. Tognaccini

Introduction

Hydrostatics

Fundamental principles

Incompressible inviscid flow

Effects of viscosity

Effects of compressibility

Aircraft lift-drag polar

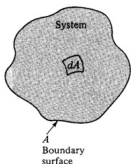

$$\mathcal{M}\delta w = -ds \int_A p dA = -pd\mathcal{V}$$

$$\delta w = -pdv; \quad v = \frac{1}{\rho}: \text{specific volume}$$

First law of Thermodynamics eq. (39) gives:

$$\delta q = de + pdv \quad (40)$$

Introducing the specific enthalpy $h = e + pv$, differentiating it and replacing in eq. (40):

$$\delta q = dh - vdp \quad (41)$$



Energy equation (3/3)

Aerodynamics

R. Tognaccini

Introduction

Hydrostatics

Fundamental principles

Incompressible inviscid flow

Effects of viscosity

Effects of compressibility

Aircraft lift-drag polar

- Assume the flow is adiabatic: $\delta q = 0$.
- Compute dp along a streamline from momentum equation eq. (35): $dp = -\frac{1}{\nu} V dV$.

First law of Thermodynamics eq. (41) gives:

$$dh + VdV = 0 \quad (42)$$

Integrating along a streamline:

Energy equation (in a steady, adiabatic flow)

$$h + \frac{V^2}{2} = \text{const} \quad (43)$$



Some remarks on the energy equation

Aerodynamics

R. Tognaccini

Introduction

Hydrostatics

Fundamental principles

Incompressible inviscid flow

Effects of viscosity

Effects of compressibility

Aircraft lift-drag polar

- It holds along a streamline for a **steady, inviscid** and **adiabatic** flow.
- In the case of a body immersed in an uniform stream, the constant is the same everywhere:

$$h + \frac{V^2}{2} = h_\infty + \frac{V_\infty^2}{2} \quad (44)$$

- For a perfect gas: $h = C_p T$,
 C_p : specific heat at constant pressure.
- Energy equation allows to study the quasi-1d **compressible** flow.
- In **incompressible**, adiabatic and inviscid flow $h = p/\rho$:
Bernoulli's and energy equations are **coincident**.



Isentropic flow

Aerodynamics

R. Tognaccini

Introduction

Hydrostatics

Fundamental principles

Incompressible inviscid flow

Effects of viscosity

Effects of compressibility

Aircraft lift-drag polar

- From the energy equation for a perfect gas in adiabatic flow ($\gamma = C_p/C_v$, $R = C_p - C_v$):

$$\frac{T_0}{T} = 1 + \frac{\gamma - 1}{2} M^2 \quad (45)$$

- An adiabatic, inviscid and subsonic flow is also **isentropic**. For a perfect gas:

$$\frac{p_0}{p} = \left(\frac{\rho_0}{\rho}\right)^\gamma; \quad \frac{\rho_0}{\rho} = \left(\frac{T_0}{T}\right)^{1/(\gamma-1)}; \quad \frac{p_0}{p} = \left(\frac{T_0}{T}\right)^{\gamma/(\gamma-1)} \quad (46)$$

- T_0 , p_0 and ρ_0 are respectively named **total** or **stagnation** temperature, pressure and density in compressible flow.



Practical applications

Aerodynamics

R. Tognaccini

Introduction

Hydrostatics

Fundamental principles

Incompressible inviscid flow

Effects of viscosity

Effects of compressibility

Aircraft lift-drag polar

Problem n. 6

For a given altitude and freestream Mach number compute the maximum surface temperature on the aircraft

- $T_{max} \approx T_0$
- $T_{max} \approx \left(1 + \frac{\gamma-1}{2} M_\infty^2\right) T_\infty$



The speed of sound (1/2)

Aerodynamics

R. Tognaccini

Introduction

Hydrostatics

Fundamental principles

Incompressible inviscid flow

Effects of viscosity

Effects of compressibility

Aircraft lift-drag polar

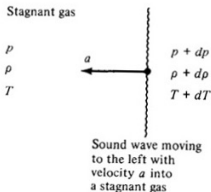

Sound wave moving in a fluid at rest

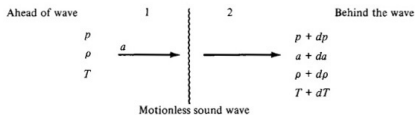

Reference system attached to the sound wave

Continuity equation:

$$\rho a = (\rho + d\rho)(a + da)$$

Neglecting smaller term $d\rho da$:

$$a = -\rho \frac{da}{d\rho} \quad (47)$$

From momentum eq. (35) with $V = a$:

$$da = -\frac{dp}{\rho a}$$



The speed of sound (2/2)

Aerodynamics

R. Tognaccini

Introduction

Hydrostatics

Fundamental principles

Incompressible inviscid flow

Effects of viscosity

Effects of compressibility

Aircraft lift-drag polar

Replacing in eq. (47):

$$a^2 = \frac{dp}{d\rho} \quad (48)$$

The process is isentropic $p = k\rho^\gamma$, therefore

Speed of sound in a perfect gas:

$$a = \sqrt{\gamma \frac{p}{\rho}} = \sqrt{\gamma RT} \quad (49)$$

since for a perfect gas $p/\rho = RT$.



Application: airspeed measurement

The Pitot tube

Aerodynamics

R. Tognaccini

Introduction

Hydrostatics

Fundamental principles

Incompressible inviscid flow

Effects of viscosity

Effects of compressibility

Aircraft lift-drag polar

The Pitot tube measures the freestream dynamic pressure.

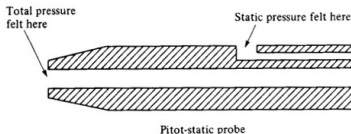

Incompressible flow

- 1 The Pitot tube measures the pressure difference Δp between the two pressure probes.
- 2 If properly placed, the static probe is at $p = p_\infty$, whereas the total pressure probe is at $p = p_0$: measured $\Delta p = p_0 - p_\infty$.
- 3 From the Bernoulli's equation: $q = \Delta p$.

The Pitot tube measures the **dynamic pressure** of the freestream.



Application: true and equivalent airspeeds in incompressible flow

Aerodynamics

R. Tognaccini

Introduction

Hydrostatics

Fundamental
principles

Incompressible
inviscid flow

Effects of
viscosity

Effects of
compressibility

Aircraft
lift-drag polar

In incompressible flow, the freestream velocity (*TAS*, True Air Speed) can be obtained by the dynamic pressure q if the correct ρ_∞ at flight level is known:

$$TAS = V_\infty = \sqrt{\frac{2q}{\rho_\infty}} \quad (50)$$

The instrument display in the cockpit usually adopts standard density at sea level ρ_{SL} to convert q in airspeed; therefore the displayed velocity is:

$$EAS = V_e = \sqrt{\frac{2q}{\rho_{SL}}} \quad (51)$$

EAS stands for Equivalent Air Speed, i.e. the true freestream velocity if $\rho_\infty = \rho_{SL}$.



Application: airspeed measurement in compressible **subsonic** flow

Aerodynamics

R. Tognaccini

Introduction

Hydrostatics

Fundamental
principles

Incompressible
inviscid flow

Effects of
viscosity

Effects of
compressibility

Aircraft
lift-drag polar

- As in incompressible flow, the pitot tube measures

$$\Delta p = p_0 - p_\infty.$$

- From isentropic flow equations:

$$\frac{p_0}{p_\infty} = \left(1 + \frac{\gamma - 1}{2} M_\infty^2\right)^{\gamma/(\gamma-1)} \quad (52)$$

- By some algebra:

$$(TAS)^2 = V_\infty^2 = \frac{2a_\infty^2}{\gamma - 1} \left[\left(1 + \frac{\Delta p}{p_\infty}\right)^{(\gamma-1)/\gamma} - 1 \right] \quad (53)$$

- Replacing a_∞ and p_∞ with the ISA sea level values we obtain the Calibrated Air Speed (CAS):

$$(CAS)^2 = V_\infty^2 = \frac{2a_{SL}^2}{\gamma - 1} \left[\left(1 + \frac{\Delta p}{p_{SL}}\right)^{(\gamma-1)/\gamma} - 1 \right] \quad (54)$$



Application: remarks on airspeeds

Aerodynamics

R. Tognaccini

Introduction

Hydrostatics

Fundamental principles

Incompressible inviscid flow

Effects of viscosity

Effects of compressibility

Aircraft lift-drag polar

For an aircraft the real interest is in:

- Dynamic pressure, responsible for the lift.
- The true freestream Mach number, which identifies the flow regime.

Problem n. 7

For a given altitude and freestream velocity of an aircraft, compare *TAS*, *EAS* and *CAS*.



Incompressible inviscid flow

Aerodynamics

R. Tognaccini

Introduction

Hydrostatics

Fundamental principles

Incompressible inviscid flow

Effects of viscosity

Effects of compressibility

Aircraft lift-drag polar

Hypotheses:

- The flow is steady.
- The flow is incompressible ($M = 0$) or iposonic ($M \approx 0$)⁵.
- The flow is inviscid ($Re \rightarrow \infty$) and adiabatic.

Solution strategy:

- 1 Flow conditions \underline{V} , p needs to be known in one point (freestream for instance).
- 2 Velocity \underline{V} is obtained solving continuity equation.
- 3 Pressure p is obtained from Bernoulli's equation.

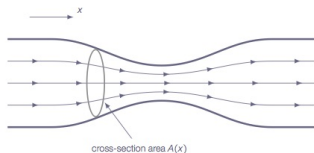

An example:

Quasi-1d (horizontal) channel flow

$$V(x) = \frac{A_1(x)}{A(x)}$$

$$p(x) = p_1 + \frac{1}{2} \rho (V_1^2 - V^2)$$

⁵A rule of thumb is $M < 0.3$ everywhere



Two-dimensional flow

The simplest airfoil: the circular cylinder

Aerodynamics

R. Tognaccini

Introduction

Hydrostatics

Fundamental principles

Incompressible inviscid flow

Effects of viscosity

Effects of compressibility

Aircraft lift-drag polar

- On a solid wall $\underline{V} = 0$ because of viscosity.
- In inviscid flow \underline{V} is tangent to the wall.

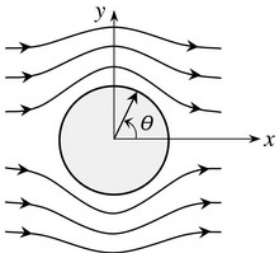

On the cylinder wall:

Pressure coefficient:

$$C_p = \frac{p - p_\infty}{\frac{1}{2} \rho_\infty V_\infty^2} \quad (55)$$

From Bernoulli's equation:

$$C_p = 1 - \left(\frac{V}{V_\infty} \right)^2 \quad (56)$$

$$V = 2V_\infty \sin \theta \quad , \quad C_p = 1 - 4 \sin^2 \theta \quad (57)$$



Pressure and forces on the cylinder

Aerodynamics

R. Tognaccini

Introduction

Hydrostatics

Fundamental principles

Incompressible inviscid flow

Effects of viscosity

Effects of compressibility

Aircraft lift-drag polar

- Two stagnation points: $\theta = 0^\circ$ and $\theta = 180^\circ$.
- $C_{p_{max}} = 1$ in stagnation points (incompressible flow).
- $C_{p_{min}} = -3$ at $\theta = 90^\circ, 270^\circ$.
- Lift and drag (per unit length) can be obtained integrating pressure on the cylinder surface.
- Pressure field is symmetric respect to x and y axes.
- Straightforward consequence: both lift and **drag** are zero.

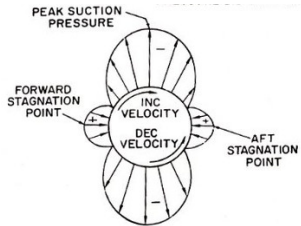

D'Alembert paradox:

In inviscid, two-dimensional and subsonic flow the drag is zero.



The relevance of vorticity

Aerodynamics

R. Tognaccini

Introduction

Hydrostatics

Fundamental principles

Incompressible inviscid flow

Effects of viscosity

Effects of compressibility

Aircraft lift-drag polar

Vorticity: $\underline{\omega} = 2\underline{\Omega}$, $\underline{\Omega}$: angular velocity of the fluid particle.

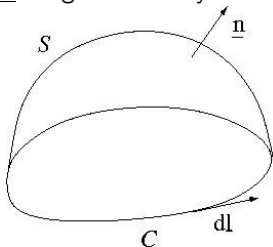

Stokes' theorem:

$$\int_S \underline{n} \cdot \underline{\omega} dS = \oint_C \underline{V} \cdot d\underline{l} = \Gamma \quad (58)$$

Γ : Circulation on the circuit C .

$d\underline{l}$: infinitesimal displacement tangent to C



Vortex lines, vortex tubes and vortices

Aerodynamics

R. Tognaccini

Introduction

Hydrostatics

Fundamental principles

Incompressible inviscid flow

Effects of viscosity

Effects of compressibility

Aircraft lift-drag polar

Vortex line a curve in space in each point tangent to particle vorticity.

Vortex tube the set of vortex lines crossing a circuit.

$$\Gamma = \oint_C \underline{V} \cdot d\underline{l} \text{ intensity of the vortex tube.}$$

Vortex a vortex tube of infinitesimal section and finite intensity.

A region in which $\underline{\omega} = 0$ is named **irrotational**.

Crocco's theorem:

An inviscid, steady region characterized by an uniform upstream flow is irrotational.



Helmholtz's theorems

Aerodynamics

R. Tognaccini

Introduction

Hydrostatics

Fundamental principles

Incompressible inviscid flow

Effects of viscosity

Effects of compressibility

Aircraft lift-drag polar

1st Helmholtz's theorem:

The intensity of a vortex tube is constant along its axis.

Corollary:

A vortex tube is closed or starts and ends at the boundary of the flow domain.

Isolated vortex tube a vortex tube immersed in an irrotational region.

2nd Helmholtz's theorem:

The circulations of all circuits surrounding an isolated vortex tube is the same and is equal to the vortex tube intensity.



The infinite straight vortex in inviscid (ideal) flow

Aerodynamics

R. Tognaccini

Introduction

Hydrostatics

Fundamental principles

Incompressible inviscid flow

Effects of viscosity

Effects of compressibility

Aircraft lift-drag polar

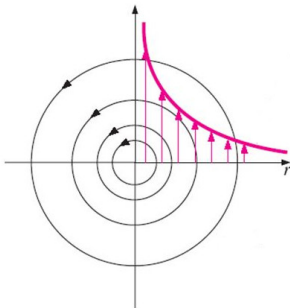

- The flow is 2d in planes orthogonal to the vortex.
- Streamlines are concentric circumferences.
- $V = \frac{\Gamma}{2\pi r}$, Γ : vortex intensity.
- From Bernoulli's theorem pressure is constant on a streamline and infinitely low in the vortex core.
- In a real flow the vortex core has a finite thickness in which $V \approx \Omega r$.



Rotating circular cylinder

The Magnus effect

Aerodynamics

R. Tognaccini

Introduction

Hydrostatics

Fundamental principles

Incompressible inviscid flow

Effects of viscosity

Effects of compressibility

Aircraft lift-drag polar

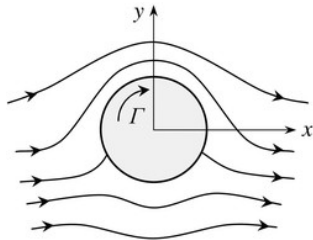
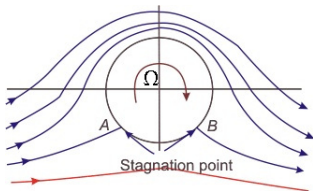

- Due to viscosity on the body surface $V = \Omega R$ and a circulation $\Gamma = 2\pi\Omega R^2$ is introduced.
- The effect of rotation is obtained by assuming that in the cylinder centre there is a vortex of intensity Γ .
- the flow is no more symmetric and lift is generated.



Kutta-Jukowskij theorem

Aerodynamics

R. Tognaccini

Introduction

Hydrostatics

Fundamental principles

Incompressible inviscid flow

Effects of viscosity

Effects of compressibility

Aircraft lift-drag polar

Hypotheses

- 2d body of arbitrary shape.
- Steady, inviscid, subsonic flow.

Theorem:

$$l = \rho_{\infty} V_{\infty} \Gamma \quad (59)$$

- The theorem highlights the presence of circulation if there is lift and vice versa.
- Stokes' theorem highlights the necessity of vorticity to have circulation. . .
- **... but the flow is irrotational!** (see Crocco's theorem).
- Again, another inconsistency of the inviscid flow theory.



The Kutta condition (1/2)

Aerodynamics

R. Tognaccini

Introduction

Hydrostatics

Fundamental principles

Incompressible inviscid flow

Effects of viscosity

Effects of compressibility

Aircraft lift-drag polar

- In the case of a 2d body of **smooth shape** in inviscid, subsonic flight $\Gamma = 0$ and, according to Kutta-Jukowskij theorem, lift $l = 0$.
- It is necessary to introduce a particular shape to obtain circulation Γ and therefore lift: the **airfoil**.
- The airfoil is a 2d body characterized by a **geometric discontinuity at trailing edge**.

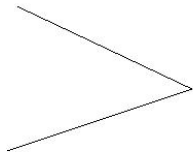

A

sharp trailing edge

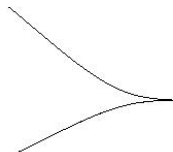

B

cusp trailing edge



The Kutta condition (2/2)

Aerodynamics

R. Tognaccini

Introduction

Hydrostatics

Fundamental principles

Incompressible inviscid flow

Effects of viscosity

Effects of compressibility

Aircraft lift-drag polar

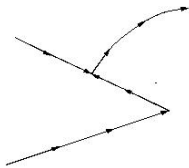

A

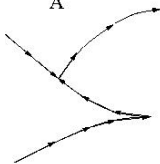

B

- Solution A is unphysical, because it requires an infinite acceleration at trailing edge.
- Kutta condition: $\underline{V} = 0$ at a sharp trailing edge; \underline{V} is continuous at a cusp trailing edge.
- Due to Kutta condition around the airfoil circulation is generated and therefore lift!



The lift of an airfoil

Aerodynamics

R. Tognaccini

Introduction

Hydrostatics

Fundamental principles

Incompressible inviscid flow

Effects of viscosity

Effects of compressibility

Aircraft lift-drag polar

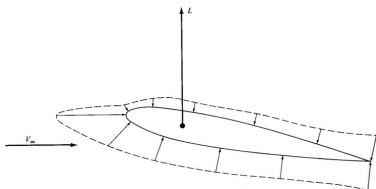

p_l : pressure on lower side;

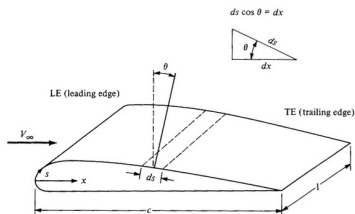

p_u : pressure on upper side.

$$\begin{aligned}
 l &= \int_{LE}^{TE} p_l \cos \theta ds - \int_{LE}^{TE} p_u \cos \theta ds \\
 &= \int_0^c (p_l - p_\infty) dx - \int_0^c (p_u - p_\infty) dx \quad (60)
 \end{aligned}$$

$$C_l = \int_0^1 (C_{p_l} - C_{p_u}) d\left(\frac{x}{c}\right) \quad (61)$$



The pressure coefficient diagram

Aerodynamics

R. Tognaccini

Introduction

Hydrostatics

Fundamental principles

Incompressible inviscid flow

Effects of viscosity

Effects of compressibility

Aircraft lift-drag polar

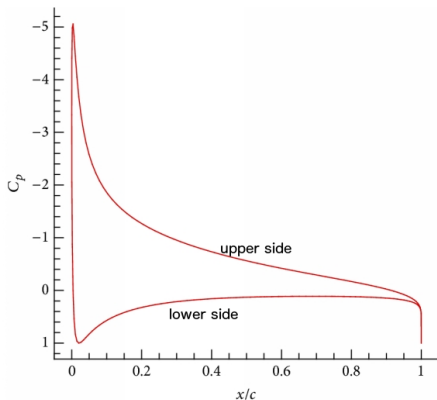

NACA 0012 airfoil. $M_\infty = 0$, $Re_\infty = \infty$, $\alpha = 9\text{deg}$.

- Airfoil load: $\Delta C_p = C_{p_l} - C_{p_u}$ $C_l = \int_0^1 \Delta C_p d\left(\frac{x}{c}\right)$
- The area within the red curve is equal to airfoil C_l !



Thin airfoil theory

in inviscid incompressible flow

Aerodynamics

R. Tognaccini

Introduction

Hydrostatics

Fundamental principles

Incompressible inviscid flow

Effects of viscosity

Effects of compressibility

Aircraft lift-drag polar

Hypotheses:

- steady 2d, inviscid, incompressible flow;
- thin airfoil of small camber at small angle of attack.

Lift coefficient:

$$C_l = C_{l\alpha}(\alpha - \alpha_{zI}) \quad (62)$$

Moment coefficient:

$$C_{m_{le}} = C_{m0} - \frac{C_l}{4} \quad (63)$$

$$C_{m_{1/4}} = C_{m0} \quad (64)$$

$$C_{l\alpha} = 2\pi, \quad \alpha_{zI} \propto \text{camber}, \quad C_{m0} \propto \text{camber}$$



Main results of thin airfoil theory

Aerodynamics

R. Tognaccini

Introduction

Hydrostatics

Fundamental principles

Incompressible inviscid flow

Effects of viscosity

Effects of compressibility

Aircraft lift-drag polar

- Lift curve is a straight line with $C_{l\alpha} = 2\pi$.
- $\alpha_{zI} < 0$ for positive camber and $\alpha_{zI} \propto \text{camber}$.
- C_{mIe} linearly decreases with α and C_l .
- The aerodynamic force is applied in the **pressure centre** placed at $\frac{x_{cp}}{c} = -\frac{C_{mIe}}{C_l}$.
- The moment respect to the **aerodynamic centre** which is placed at $x = c/4$ is independent of the angle of attack.



NACA airfoils

Aerodynamics

R. Tognaccini

Introduction

Hydrostatics

Fundamental principles

Incompressible inviscid flow

Effects of viscosity

Effects of compressibility

Aircraft lift-drag polar

- Modern subsonic airfoils are not thin!
- During WWI wind tunnel experiments in Germany showed relatively thick airfoils have larger $C_{l_{max}}$.
- Increased manouverability and reduced take-off lengths.
- Increased structure robustness and reduced weight.
- Bracing not required: much lower drag.
- During '30s extensive wind tunnel campaigns at NACA.
- Following WWII NACA data became public: NACA airfoils are now standard in subsonic flight.

Thick airfoil performances in inviscid incompressible flow:

- $C_{l\alpha} = 2\pi(1 + 0.77t)$, where t is the thickness ratio of the airfoil.
- α_{ZI} well predicted by thin airfoil theory.



NACA airfoils

Geometry definition

Aerodynamics

R. Tognaccini

Introduction

Hydrostatics

Fundamental principles

Incompressible inviscid flow

Effects of viscosity

Effects of compressibility

Aircraft lift-drag polar

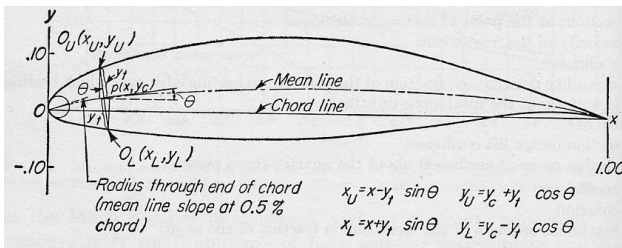

$x \in (0, 1)$, $y = y_c(x)$: mean line equation,
 $y = y_t(x)$: half-thickness equation, $\tan \theta = dy_c/dx$.

Airfoil point coordinates:

$$\begin{aligned} x_U &= x - y_t \sin \theta & y_U &= y_c + y_t \cos \theta \\ x_L &= x + y_t \sin \theta & y_L &= y_c - y_t \cos \theta \end{aligned}$$



4 digit NACA airfoils

Aerodynamics

R. Tognaccini

Introduction

Hydrostatics

Fundamental principles

Incompressible inviscid flow

Effects of viscosity

Effects of compressibility

Aircraft lift-drag polar

Half-thickness distribution:

$$y_t = \pm \frac{t}{0.20} (0.29690\sqrt{x} - 0.12600x - 0.35160x^2 + 0.28430x^3 - 0.10150x^4) . \quad (65)$$

t airfoil percentage thickness; maximum thickness at $x = 0.3$

$r_t = 1.1019t^2$, curvature radius at LE

Mean line:

$$\forall x \leq p : \quad y_c = \frac{m}{p^2} (2px - x^2) ; \quad (66)$$

$$\forall x > p : \quad y_c = \frac{m}{(1-p)^2} (1 - 2p + 2px - x^2) ; \quad (67)$$

p x position of maximum camber

m maximum camber (y value).



4 digit NACA airfoils

Numbering system

Aerodynamics

R. Tognaccini

Introduction

Hydrostatics

Fundamental principles

Incompressible inviscid flow

Effects of viscosity

Effects of compressibility

Aircraft lift-drag polar

A 4 digit NACA airfoil is identified by 4 digits: $D_1D_2D_3D_4$

$D_1/100 = m$ maximum camber

$D_2/10 = p$ position of maximum camber

$D_3D_4 = t$ maximum thickness

Example

NACA 2412 airfoil: 12% thickness, 2% camber, maximum camber placed at $x/c = 0.4$.

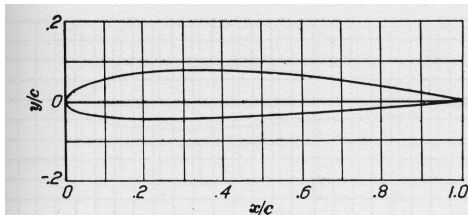



5 digit NACA airfoils

Aerodynamics

R. Tognaccini

Introduction

Hydrostatics

Fundamental principles

Incompressible inviscid flow

Effects of viscosity

Effects of compressibility

Aircraft lift-drag polar

- Designed for improved $C_{l_{max}}$ performance and reduced pitching moment.

Half-thickness:

same as 4 digit airfoils

Mean line:

$$\forall x \leq m : \quad y_c = \frac{k_1}{6} [x^3 - 3mx^2 + m^2(3 - m)x] ; \quad (68)$$

$$\forall x > m : \quad y_c = \frac{k_1 m^3}{6} (1 - x) . \quad (69)$$

linea media	m	k_1
210	0.0580	361.4
220	0.1260	51.64
230	0.2025	15.957
240	0.2900	6.643
250	0.3910	3.230



5 digit NACA airfoils

Numbering system

Aerodynamics

R. Tognaccini

Introduction

Hydrostatics

Fundamental principles

Incompressible inviscid flow

Effects of viscosity

Effects of compressibility

Aircraft lift-drag polar

A 5 digit NACA airfoil is identified by 5 digits: $D_1 D_2 D_3 D_4 D_5$

$D_1 D_2 D_3$ mean line

$D_4 D_5 = t$ maximum thickness

Example

NACA 23012 airfoil: 12% thickness, 230 mean line.

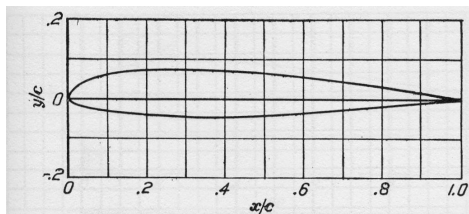

NACA 23012 airfoil



4 digit vs 5 digit NACA airfoil performance

Aerodynamics

R. Tognaccini

Introduction

Hydrostatics

Fundamental principles

Incompressible inviscid flow

Effects of viscosity

Effects of compressibility

Aircraft lift-drag polar

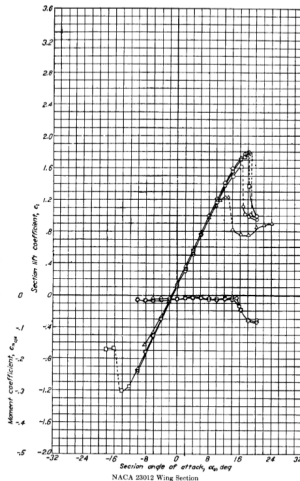
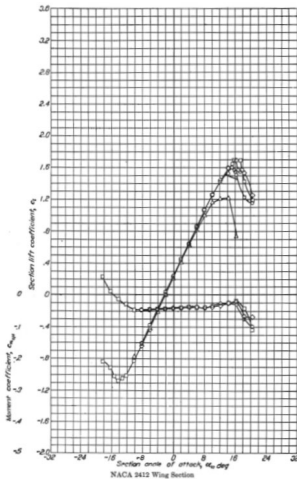



The wing of finite \mathcal{R} in inviscid, incompressible flow

Aerodynamics

R. Tognaccini

Introduction

Hydrostatics

Fundamental
principles

Incompressible
inviscid flow

Effects of
viscosity

Effects of
compressibility

Aircraft
lift-drag polar

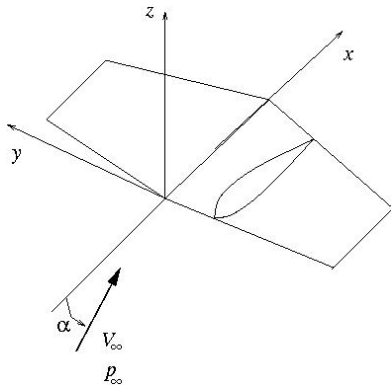

Is there the chance that the flow is 2d in planes parallel to (x, z) ?

The answer is yes if $\mathcal{R} \gg 1$ and if the sweep angle $\Lambda \approx 0$.



Genesis of the trailing vortices and lift induced drag

1/3

Aerodynamics

R. Tognaccini

Introduction

Hydrostatics

Fundamental principles

Incompressible inviscid flow

Effects of viscosity

Effects of compressibility

Aircraft lift-drag polar

We have the lift induced drag in a 3d wing but not for an airfoil in 2d flow; why?

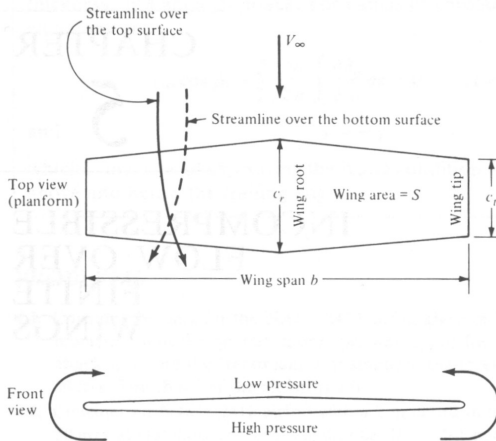



Genesis of the trailing vortices and lift induced drag

2/3

Aerodynamics

R. Tognaccini

Introduction

Hydrostatics

Fundamental principles

Incompressible inviscid flow

Effects of viscosity

Effects of compressibility

Aircraft lift-drag polar

- Lower-upper pressure difference causes a rotation of the flow around wing tips.
- Two strong counter-rotating vortices are generated at tips; they are named **free vortices**.

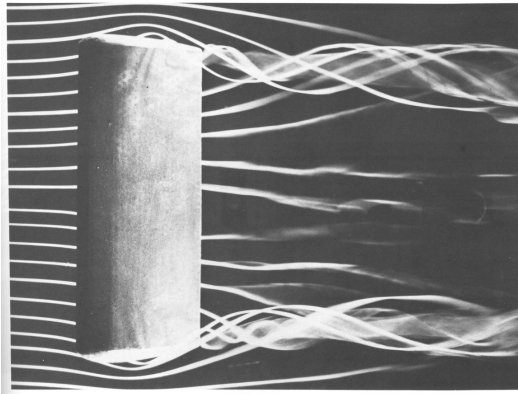



Genesis of the trailing vortices and lift induced drag

3/3

Aerodynamics

R. Tognaccini

Introduction

Hydrostatics

Fundamental principles

Incompressible inviscid flow

Effects of viscosity

Effects of compressibility

Aircraft lift-drag polar

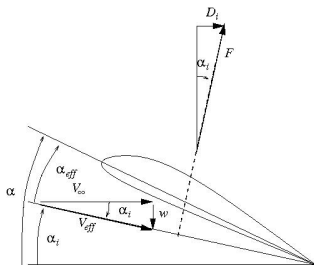

α_i induced angle of attack or downwash angle.

- The flow is 2d in planes parallel to (x, z) but...
- ... free vortices induce a **downwash** w for $-b/2 < y < b/2$ and an **upwash** for $y < -b/2$ and $y > b/2$.
- Each wing section works in a 2d flow but, due to downwash, at a **smaller** effective angle of attack $\alpha_{eff} = \alpha - \alpha_i$
- According to K-J theorem the aerodynamic force is orthogonal to V_{eff} therefore a streamwise force parallel to V_∞ arises: the **lift induced drag**.



The vortex system of the wing

Aerodynamics

R. Tognaccini

Introduction

Hydrostatics

Fundamental principles

Incompressible inviscid flow

Effects of viscosity

Effects of compressibility

Aircraft lift-drag polar

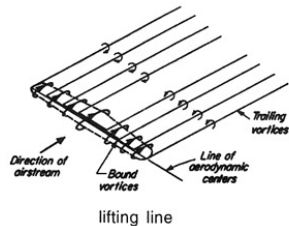
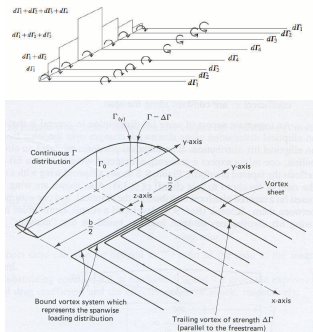

- At each wing section y the flow is 2d.
- According to K-J theorem local lift is: $l(y) = \rho V_\infty \Gamma(y)$.
- A **bound vortex** of variable intensity $\Gamma(y)$ runs along the wing.
- Since $\Gamma(y)$ varies, according to 1st Helmholtz's theorem at each y a **free vortex** compensates circulation variation $d\Gamma$.
- The free vortices are aligned with the freestream and then **roll-up**.
- The free vortices induce the downwash w .



The downwash on the wing

Aerodynamics

R. Tognaccini

Introduction

Hydrostatics

Fundamental principles

Incompressible inviscid flow

Effects of viscosity

Effects of compressibility

Aircraft lift-drag polar

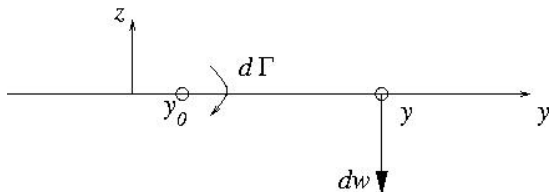

Downwash induced by an elementary infinite vortex:

$$dw = \frac{d\Gamma}{2\pi(y - y_0)}$$

Downwash induced by an elementary semi-infinite vortex:

$$dw = \frac{d\Gamma}{4\pi(y - y_0)}$$

Downwash induced by all free vortices distributed along the wing:

$$w = \int_{-b/2}^{+b/2} \frac{1}{4\pi(y - y_0)} \frac{d\Gamma}{dy_0} dy_0 \quad (70)$$



The downwash in the far wake

Aerodynamics

R. Tognaccini

Introduction

Hydrostatics

Fundamental principles

Incompressible inviscid flow

Effects of viscosity

Effects of compressibility

Aircraft lift-drag polar

- Free vortices are distributed along the whole wing.
- Wingtip vortices are more visible than the others because of their stronger intensity.
- In the far wake the downwash is twice the one on the wing: $w_{\infty} = 2w$.

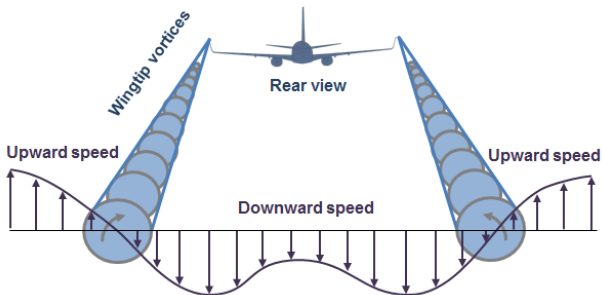



The lifting line equation

Aerodynamics

R. Tognaccini

Introduction

Hydrostatics

Fundamental principles

Incompressible inviscid flow

Effects of viscosity

Effects of compressibility

Aircraft lift-drag polar

Downwash angle:

$$\alpha_i(y) \approx \frac{w}{V_\infty} = \frac{1}{4\pi V_\infty} \int_{-b/2}^{+b/2} \frac{1}{(y - y_0)} \frac{d\Gamma}{dy_0} dy_0 \quad (71)$$

Effective AoA: $\alpha_{eff}(y) = \alpha(y) - \alpha_i(y)$.⁶

Since $dL = \rho V_\infty \Gamma dy$ and due to definition of C_l :

$$\frac{2\Gamma(y)}{V_\infty c(y)} = C_{l\alpha}(y) [\alpha(y) - \alpha_i(y)] \quad (72)$$

By equation (71):

Lifting line equation:

$$\frac{2\Gamma(y)}{V_\infty c C_{l\alpha}} + \frac{1}{4\pi V_\infty} \int_{-b/2}^{+b/2} \frac{1}{(y - y_0)} \frac{d\Gamma}{dy_0} dy_0 = \alpha(y) \quad (73)$$

⁶ α measured respect to airfoil zero lift line.



Lift and induced drag of the wing

Aerodynamics

R. Tognaccini

Introduction

Hydrostatics

Fundamental principles

Incompressible inviscid flow

Effects of viscosity

Effects of compressibility

Aircraft lift-drag polar

The load along the wing: $\gamma = \frac{\Gamma}{V_\infty b} = \frac{cC_l}{2b}$.⁷

$L = \int_{-b/2}^{+b/2} l dy$ and $D_i = \int_{-b/2}^{+b/2} l \alpha_i dy$, therefore

Lift coefficient:

$$C_L = \mathcal{R} \int_{-1}^{+1} \gamma(\eta) d\eta \quad (74)$$

Induced drag coefficient:

$$C_{D_i} = \mathcal{R} \int_{-1}^{+1} \gamma(\eta) \alpha_i(\eta) d\eta \quad (75)$$

where $\eta = \frac{y}{b/2}$.

⁷Last equality obtained thanks to the K-J theorem.



The elliptic wing

Aerodynamics

R. Tognaccini

Introduction

Hydrostatics

Fundamental principles

Incompressible inviscid flow

Effects of viscosity

Effects of compressibility

Aircraft lift-drag polar

Only one explicit solution of the lifting line equation: **the elliptic wing**.

1 elliptic distribution of the airfoil chords along the span:

$$c = c_0 \sqrt{1 - \eta^2};$$

2 same airfoil along the span;

3 no twist.

Elliptic wing performance:

$$\gamma(\eta) = \frac{2C_L}{\pi \mathcal{R}} \sqrt{1 - \eta^2}, \quad \alpha_i = \frac{C_L}{\pi \mathcal{R}} \quad (76)$$

$$C_L = C_{L\alpha}(\alpha - \alpha_{zL}), \quad C_{L\alpha} = \frac{C_{l\alpha}}{1 + \frac{C_{l\alpha}}{\pi \mathcal{R}}}, \quad \alpha_{zL} = \alpha_{zl} \quad (77)$$

$$C_{Di} = \frac{C_L^2}{\pi \mathcal{R}} \quad (78)$$



On the elliptic wing performance

Aerodynamics

R. Tognaccini

Introduction

Hydrostatics

Fundamental principles

Incompressible inviscid flow

Effects of viscosity

Effects of compressibility

Aircraft lift-drag polar

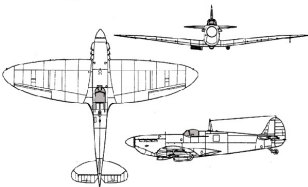
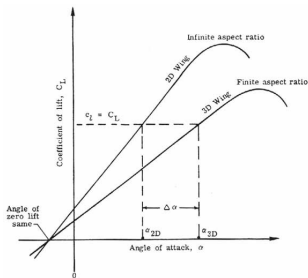

- Wing performance only depend on the load distribution.
- The elliptic wing has an elliptic load distribution: $\gamma = \gamma_0 \sqrt{1 - \eta^2}$.
- There are infinite way to obtain an elliptic load distribution.
- $C_{L\alpha} < C_{I\alpha}$.
- $C_L < C_I$ at the same AoA.
- Among the wings of *simple* shape the elliptic wing provides the minimum C_{D_i} at the same C_L .

Lift performance of an arbitrary unswept wing are qualitatively similar to the ones of the elliptic wing.



Practical applications

Aerodynamics

R. Tognaccini

Introduction

Hydrostatics

Fundamental
principles

Incompressible
inviscid flow

Effects of
viscosity

Effects of
compressibility

Aircraft
lift-drag polar

Problem n. 7

Given \mathcal{R} and C_L of an elliptic wing compute the corresponding airfoil C_f .

Problem n. 8

Given \mathcal{R} and C_L of a wing compute the average load γ .



The load along the wing

Aerodynamics

R. Tognaccini

Introduction

Hydrostatics

Fundamental
principles

Incompressible
inviscid flow

Effects of
viscosity

Effects of
compressibility

Aircraft
lift-drag polar

- $\gamma = \frac{cC_l}{2b}$ has important aerodynamic role but it is also fundamental to design the wing structure.
- $\gamma = 0$ at wing tips.
- An asymmetrical $\gamma(\eta)$ respect to $\eta = 0$ allows for obtaining a roll moment necessary for aircraft veer.
- Local load γ at a station η can be changed by changing local chord c or local lift coefficient C_l . Since wing AoA is fixed, C_l can only be changed by wing twist.



Basic and additional load

Aerodynamics

R. Tognaccini

Introduction

Hydrostatics

Fundamental principles

Incompressible inviscid flow

Effects of viscosity

Effects of compressibility

Aircraft lift-drag polar

Load decomposition:

$$\gamma(\eta) = \gamma_b(\eta) + \gamma_a(\eta) \quad (79)$$

γ_b **basic load**, the load distribution when $C_L = 0^8$. It depends on the wing twist ϵ , $\gamma_b(\eta) = 0$ if $\epsilon = 0$.

γ_a **additional load**, the difference between the actual and the basic load. It depends on the wing planform.

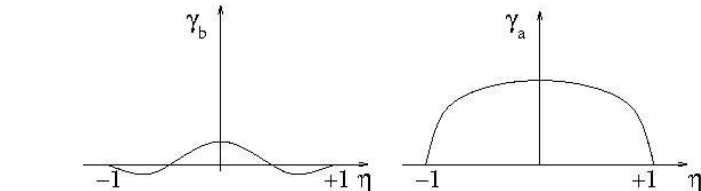

⁸Note that the area underlying $\gamma(\eta)$ function is proportional to lift coefficient.



Schrenk's method

for the computation of the wing load distribution

Aerodynamics

R. Tognaccini

Introduction

Hydrostatics

Fundamental principles

Incompressible inviscid flow

Effects of viscosity

Effects of compressibility

Aircraft lift-drag polar

Input data:

- 1 Chord distribution $c=c(y)$;
- 2 Airfoil performances $C_{l\alpha} = C_{l\alpha}(y)$;
- 3 Aerodynamic twist $\epsilon_a = \epsilon_a(y)$.⁹

$$C_L = \mathcal{R} \left(\int_{-1}^{+1} \gamma_b d\eta + \int_{-1}^{+1} \gamma_a d\eta \right) = \mathcal{R} \int_{-1}^{+1} \gamma_a d\eta \quad (80)$$

- C_L only depends on γ_a .
- Since C_L linearly varies: $\gamma_a = C_L \gamma_{a1}$, where γ_{a1} is the additional load for $C_L = 1$.

Therefore:

$$\gamma = \gamma_b + C_L \gamma_{a1} \quad (81)$$

⁹ ϵ_a is referenced respect to zero lift lines.



Schrenk's method

Computation of the additional load γ_a

Aerodynamics

R. Tognaccini

Introduction

Hydrostatics

Fundamental principles

Incompressible inviscid flow

Effects of viscosity

Effects of compressibility

Aircraft lift-drag polar

- $\mathcal{R} \rightarrow \infty$: $\alpha_i \rightarrow 0$ and $\gamma_a = cC_l/(2b)$, i.e. load is proportional to the chord.
- $\mathcal{R} \rightarrow 0$: the load is elliptic.
- Schrenk's hypothesis: for intermediate \mathcal{R} , γ_{a1} is the average between the chord distribution and the one of an elliptic wing with same wing surface S :

$$\gamma_{a1}(\eta) = \frac{1}{2} \left[\frac{c(\eta)}{2b} + \frac{c_{ell}}{2b} \right] \quad (82)$$

$$c_{ell}(\eta) = c_0 \sqrt{1 - \eta^2} = c_0 \sin \theta; \quad c_0 = \frac{4S}{\pi b}; \quad \frac{c_0}{2b} = \frac{2}{\pi \mathcal{R}};$$
$$\eta = -\cos \theta; \quad d\eta = \sin \theta d\theta.$$

$$\mathcal{R} \int_{-1}^{+1} \gamma_{a1} d\eta = \frac{\mathcal{R}}{4b} \left[\int_{-1}^{+1} c(\eta) d\eta + \frac{4S}{\pi b} \int_{-1}^{+1} \sqrt{1 - \eta^2} d\eta \right] = 1 \quad (83)$$



Schrenk's method

Computation of the basic load γ_b

Aerodynamics

R. Tognaccini

Introduction

Hydrostatics

Fundamental principles

Incompressible inviscid flow

Effects of viscosity

Effects of compressibility

Aircraft lift-drag polar

- 1 Compute α_{zL} by approximate formula:

$$\alpha_{zL} = \frac{2}{S} \int_0^{b/2} c\epsilon_a(y) dy \quad (84)$$

- 2 Compute a first guess of the basic AoA α_b by formula:

$$\bar{\alpha}_b(y) = \alpha_{zL} - \epsilon_a(y) \quad (85)$$

- 3 Effective α_b is obtained by averaging $\bar{\alpha}_b$ and the basic angle of the *untwisted* wing (for which $\alpha_{bc0} = 0$), therefore $\alpha_b = \bar{\alpha}_b/2$ and

$$\gamma_b(\eta) = \frac{cC_{l_b}}{2b} = \frac{cC_{l_\alpha}\alpha_b}{2b} = \frac{cC_{l_\alpha}\bar{\alpha}_b}{4b} \quad (86)$$



Tapered and elliptic wings

Aerodynamics

R. Tognaccini

Introduction

Hydrostatics

Fundamental
principles

Incompressible
inviscid flow

Effects of
viscosity

Effects of
compressibility

Aircraft
lift-drag polar

A tapered (trapezoidal) wing planform:

$$\frac{c}{2b} = \frac{1}{(1 + \lambda)\mathcal{R}} [(1 - \eta) + \lambda\eta]$$

where $\lambda = c_t/c_r$.

- A tapered wing with a proper twist distribution can provide an elliptic load, therefore the same performance of the elliptic wing.



Wings of small aspect ratio

Aerodynamics

R. Tognaccini

Introduction

Hydrostatics

Fundamental principles

Incompressible inviscid flow

Effects of viscosity

Effects of compressibility

Aircraft lift-drag polar

- Flow in planes parallel to the wing symmetry plane is no more 2d.
- $C_L = C_{L\alpha}(\alpha - \alpha_{zL})$ as for large \mathcal{R} , but...
- ... $C_{L\alpha} \approx \frac{\pi}{2}\mathcal{R}$, much smaller!
- Stall angle α_s much larger than for high aspect ratio wings (30deg and beyond).
- Load distribution along y is elliptic and $C_{D_i} \approx \frac{C_L^2}{\pi\mathcal{R}}$



The leading edge vortex

Aerodynamics

R. Tognaccini

Introduction

Hydrostatics

Fundamental principles

Incompressible inviscid flow

Effects of viscosity

Effects of compressibility

Aircraft lift-drag polar

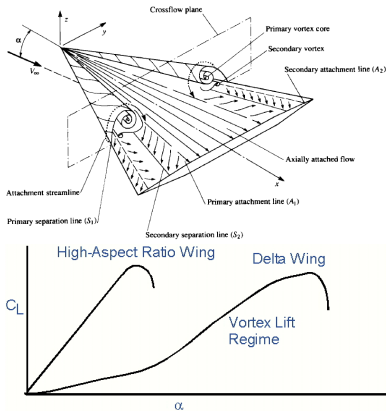

- The flow is 2d in the crossflow plane!
- Lift is due to the low pressure on the upper wing induced by LE vortices.
- enhanced lift due to LE vortices.
- Stall due to LE vortex breakdown.



The effects of viscosity

Three unresolved questions of inviscid theory

Aerodynamics

R. Tognaccini

Introduction

Hydrostatics

Fundamental principles

Incompressible inviscid flow

Effects of viscosity

Effects of compressibility

Aircraft lift-drag polar

- 1 Why theoretical drag is zero in 2d subsonic flows against the experience (D'Alembert paradox)?
- 2 How is the vorticity generated, necessary to obtain the circulation around a lifting airfoil?
- 3 In the inviscid model, velocity on the body wall is tangent but different than zero, but experience shows $\underline{V} = 0$: why is possible a good prediction of pressure on the body by Bernoulli's equation?



The boundary layer theory

Aerodynamics

R. Tognaccini

Introduction

Hydrostatics

Fundamental principles

Incompressible inviscid flow

Effects of viscosity

Effects of compressibility

Aircraft lift-drag polar

- It must exist a region near the body of thickness δ in which we have a velocity variation ΔV from zero to $V \approx V_\infty$.
- Experience shows that the larger is V_∞ , the smaller is δ .
- If $Re = \frac{\rho_\infty V_\infty L}{\mu_\infty} \gg 1$: $\frac{\delta}{L} \ll 1$.
- This region of thickness δ is named **boundary layer**.
- In the boundary layer, friction stress $\tau = \mu \frac{\partial V}{\partial y}$, where $\frac{\partial V}{\partial y} \approx \frac{V_\infty}{\delta}$. for $\delta \rightarrow 0$ $\frac{\partial V}{\partial y} \rightarrow \infty$: **friction stress is significant even if μ is very small.**

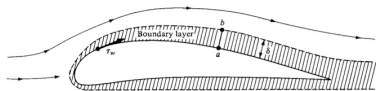
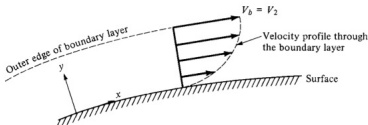



Boundary layer theory results

Aerodynamics

R. Tognaccini

Introduction

Hydrostatics

Fundamental principles

Incompressible inviscid flow

Effects of viscosity

Effects of compressibility

Aircraft lift-drag polar

- Assuming $\tau \approx \rho V^2$ we can obtain that $\frac{\delta}{L} \approx O\left(\frac{1}{\sqrt{Re_L}}\right)$ in the boundary layer: confirmed that, as $Re_L \rightarrow \infty$ $\delta/L \rightarrow 0$.
- Inviscid state ($Re_L = \infty$) is never obtained in practice, because even if $Re_L \gg 1$ it cannot be really infinite. . .
- . . . but outside boundary layer $\frac{\partial V}{\partial y}$ is no more very large and the flow is effectively inviscid in practice.
- On the wall viscous stress $\tau_w = \mu \left(\frac{\partial V}{\partial y}\right)_w$ is not negligible and is responsible for drag in 2d subsonic flows: **D'Alembert paradox resolved**.
- Inside the boundary layer $\omega = \frac{\partial v}{\partial y}$: **the boundary layer generates vorticity necessary to obtain lift** (as predicted by K-J theorem).
- Inside the boundary layer: $\frac{\partial p}{\partial y} = 0 \Rightarrow p = p(x)$: pressure on the wall is equal to pressure at the same x but at the border of the boundary layer where the flow is frictionless and Bernoulli's theorem valid with all the results of inviscid theory.



The laminar boundary layer on the flat plate at $\alpha = 0\text{deg}$ ($\rho(x) = \rho_\infty$)

Aerodynamics

R. Tognaccini

Introduction

Hydrostatics

Fundamental
principles

Incompressible
inviscid flow

Effects of
viscosity

Effects of
compressibility

Aircraft
lift-drag polar

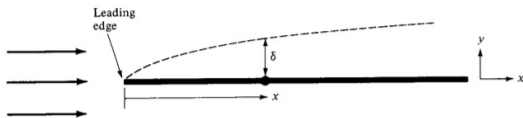

- Local Reynolds number: $Re_x = \frac{\rho_\infty V_\infty x}{\mu_\infty}$.
- Boundary layer thickness: $\delta(x) = \frac{5}{\sqrt{Re_x}} x$.
- Friction drag (per unit length): $d_f = \int_0^L \tau_w dx$.
- Skin friction: $C_f(x) = \frac{\tau_w}{\frac{1}{2} \rho_\infty V_\infty^2} = \frac{0.664}{\sqrt{Re_x}}$.
- Friction drag coefficient: $C_{d_f} = \int_0^1 C_f d\left(\frac{x}{L}\right) = \frac{1.328}{\sqrt{Re_L}}$.



Practical applications

Aerodynamics

R. Tognaccini

Introduction

Hydrostatics

Fundamental principles

Incompressible inviscid flow

Effects of viscosity

Effects of compressibility

Aircraft lift-drag polar

Problem n. 9

Compute the drag per unit length of a flat plate at $\alpha = 0 \text{deg}$ long 10cm in a stream at $V_\infty = 10 \text{Km/h}$ in standard ISA conditions.

Problem n. 10

Compute the boundary layer thickness at the end of the plate for the previous problem.

- Sutherland's law for viscosity of air:

$$\frac{\mu}{\mu_0} = \left(\frac{T}{T_0} \right)^{3/2} \frac{T_0 + 110K}{T + 110K} \quad (87)$$

$$T_0 = 288K, \mu_0 = 1.79 \times 10^{-5} \text{Kg}/(\text{ms})$$



The displacement thickness of a flat plate at $\alpha = 0 \text{ deg}$

Aerodynamics

R. Tognaccini

Introduction

Hydrostatics

Fundamental
principles

Incompressible
inviscid flow

Effects of
viscosity

Effects of
compressibility

Aircraft
lift-drag polar

$$\delta^*(x) = \int_0^{\infty} \left(1 - \frac{V}{V_{\infty}}\right) dy \quad (88)$$

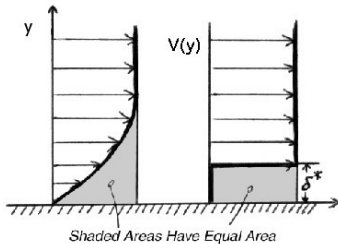

- In order to obtain in inviscid flow the same mass flux rate above a body in a real viscous flow it is necessary to thicken the body of δ^* : $\text{shaded area} = V_{\infty} \delta^*$.
- The (small) effect of the boundary on the outer inviscid flow can be obtained by thickening the body of δ^* and repeat the inviscid analysis.



The boundary layer over airfoils

Aerodynamics

R. Tognaccini

Introduction

Hydrostatics

Fundamental principles

Incompressible inviscid flow

Effects of viscosity

Effects of compressibility

Aircraft lift-drag polar

- Since δ is small and $\frac{dp}{dy}$ is negligible in the boundary layer, a first *good* estimation of pressure on the airfoil can be obtained by inviscid analysis assuming $\delta^* = 0$.
- Along the airfoil (x) we have pressure variations and the velocity profile along y inside the boundary layer can have different characteristics near the wall.

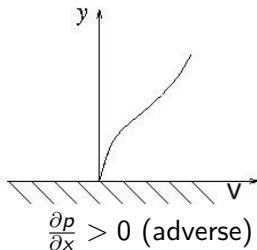
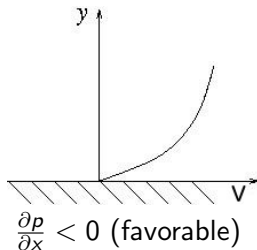



The separation point (1/2)

Aerodynamics

R. Tognaccini

Introduction

Hydrostatics

Fundamental principles

Incompressible inviscid flow

Effects of viscosity

Effects of compressibility

Aircraft lift-drag polar

$$x_s : \left(\frac{\partial V}{\partial y} \right)_{y=0} = 0$$

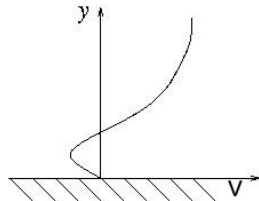
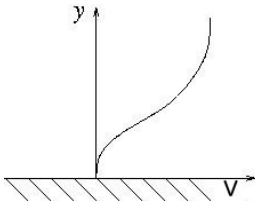

- Boundary layers with adverse pressure gradient **could** have a separation point.
- Following the separation point pressure is no more the one obtained by inviscid solution.



The separation point (2/2)

Aerodynamics

R. Tognaccini

Introduction

Hydrostatics

Fundamental principles

Incompressible inviscid flow

Effects of viscosity

Effects of compressibility

Aircraft lift-drag polar

Separated boundary layers over airfoils have two main drawbacks of:

- 1 Large separated regions reduce the pressure peak at leading edge and lead to stall.
- 2 Pressure recovery in the aft part of the airfoil is largely reduced therefore a new type of drag appears: the **form** or **wake** drag.

The term wake drag is used because bodies with large separated regions are characterized by a wake with a velocity defect.

- In cruise conditions there should not be separation on the airfoil.

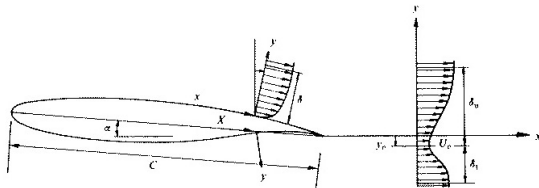



The turbulence

Reynolds' experiment

Aerodynamics

R. Tognaccini

Introduction

Hydrostatics

Fundamental principles

Incompressible inviscid flow

Effects of viscosity

Effects of compressibility

Aircraft lift-drag polar

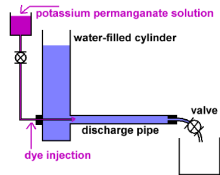
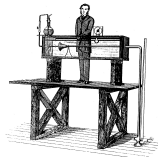

- Reynolds' channel flow experiment evidenced the existence of two flow regimes radically different:
- **Transition** from a regime to the other one depends on a **critical Reynolds number Re_{cr}** (In the case of the channel flow $Re_{cr} \approx 2200$):
 - 1 $Re < Re_{cr}$, **laminar** regime, the flow is stable and regular;
 - 2 $Re > Re_{cr}$, **turbulent** regime, the flow is unstable and strongly irregular.
- Re_{cr} is not universal, but depends on the particular flow.



The turbulent flow over a flat plate

Flow visualization at $V_\infty = 3.3\text{m/s}$, $Re_{cr} \approx 2 \times 10^5$

Aerodynamics

R. Tognaccini

Introduction

Hydrostatics

Fundamental principles

Incompressible inviscid flow

Effects of viscosity

Effects of compressibility

Aircraft lift-drag polar

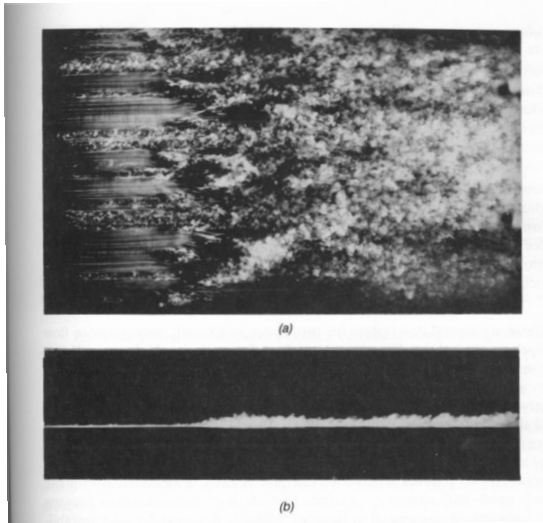

(a) upper view; (b) lateral view.



The turbulent jet

Laser induced fluorescence, $Re_D \approx 2300$

Aerodynamics

R. Tognaccini

Introduction

Hydrostatics

Fundamental
principles

Incompressible
inviscid flow

Effects of
viscosity

Effects of
compressibility

Aircraft
lift-drag polar

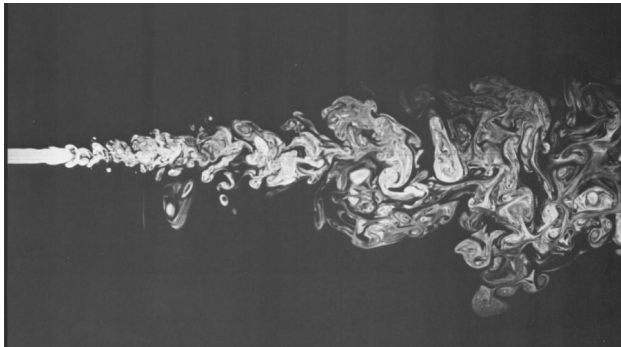



Main characteristics of turbulent flows

Aerodynamics

R. Tognaccini

Introduction

Hydrostatics

Fundamental principles

Incompressible inviscid flow

Effects of viscosity

Effects of compressibility

Aircraft lift-drag polar

- **Fluctuations** of velocity and pressure. Velocity fluctuations in all 3 directions (even for a flow that should be 2d); fluctuations are around an **average** value.
- **Eddies** of different dimensions (from 40mm to 0.05mm in the experiment of previous slide).
- **Random** variations of fluid properties; not possible a **deterministic** analysis, the process is **aleatory**.
- **Self-sustained motion**. New vortices are created to substitute the ones dissipated due to viscosity.
- **Flow mixing** much stronger than in the laminar case. Turbulent eddies move in all 3 directions and cause a strong diffusion of mass, momentum and energy.
- **Boundary layer thickness** larger than in laminar case.



Averages and fluctuations

Aerodynamics

R. Tognaccini

Introduction

Hydrostatics

Fundamental principles

Incompressible inviscid flow

Effects of viscosity

Effects of compressibility

Aircraft lift-drag polar

$\underline{V} = (u, v, w)$: instantaneous velocity field.

$\bar{\underline{V}} = (\bar{u}, \bar{v}, \bar{w})$: average velocity field.

u', v', w' : velocity fluctuations.

$$\begin{aligned}u &= \bar{u} + u' & \bar{u} &= \frac{1}{T} \int_{t_0}^{t_0+T} u dt \\v &= \bar{v} + v' & \bar{v} &= \frac{1}{T} \int_{t_0}^{t_0+T} v dt \\w &= \bar{w} + w' & \bar{w} &= \frac{1}{T} \int_{t_0}^{t_0+T} w dt\end{aligned} \quad (89)$$

$\bar{u}', \bar{v}', \bar{w}' = 0$: fluctuations measured by $\sqrt{\bar{u}'^2}$, $\sqrt{\bar{v}'^2}$, $\sqrt{\bar{w}'^2}$



Average velocity profile in turbulent flows

Aerodynamics

R. Tognaccini

Introduction

Hydrostatics

Fundamental principles

Incompressible inviscid flow

Effects of viscosity

Effects of compressibility

Aircraft lift-drag polar

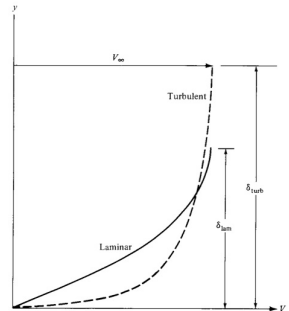
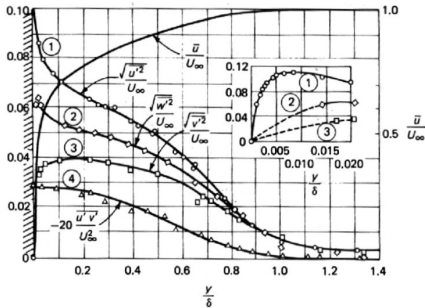

- $\sqrt{\bar{u}'^2}, \sqrt{\bar{v}'^2}, \sqrt{\bar{w}'^2} \rightarrow 0$ at the wall: **viscous sublayer**.
- Due to the increased mixing, turbulent velocity profile more "potbellied" than in the laminar case...
- ... therefore $\mu \left(\frac{\partial \bar{V}}{\partial y} \right)_w$ much larger than in laminar flow.
- **In turbulent flows friction is much larger than in the laminar case.**



The turbulent boundary layer on a flat plate

Aerodynamics

R. Tognaccini

Introduction

Hydrostatics

Fundamental principles

Incompressible inviscid flow

Effects of viscosity

Effects of compressibility

Aircraft lift-drag polar

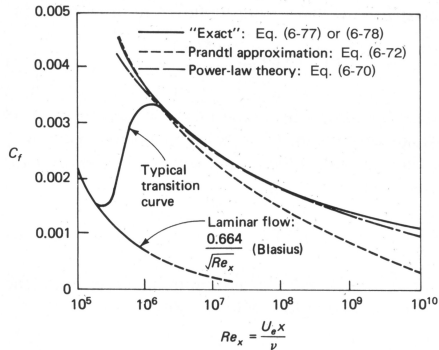

$$\frac{\delta}{x} \approx 0.37 Re_x^{-1/5}; C_f \approx 0.0592 Re_x^{-1/5}; C_d \approx 0.074 Re_L^{-1/5}.$$



Practical applications

Aerodynamics

R. Tognaccini

Introduction

Hydrostatics

Fundamental principles

Incompressible inviscid flow

Effects of viscosity

Effects of compressibility

Aircraft lift-drag polar

Problem n. 11

Compute the drag per unit length of a flat plate at $\alpha = 0deg$ long $1m$ in a stream at $V_\infty = 10m/s$ in standard ISA conditions.

Problem n. 12

Compute the boundary layer thickness at the end of the plate for the previous problem.

Problem n. 13

Recompute drag and boundary layer thickness of the previous problem assuming laminar flow.



Laminar-turbulent transition

Aerodynamics

R. Tognaccini

Introduction

Hydrostatics

Fundamental principles

Incompressible inviscid flow

Effects of viscosity

Effects of compressibility

Aircraft lift-drag polar

The transition to turbulence depends on several factors.

- 1 Reynolds number**, as already evidenced, is the first parameter.
- 2 Pressure gradient**. A laminar boundary layer is unstable if there is an inflection in the velocity profile ($\frac{\partial p}{\partial x} > 0$). In this case the boundary layer very quickly becomes turbulent.
- 3 Freestream turbulence**. Freestream flow has always a certain amount of turbulence: larger freestream turbulence facilitates transition.
- 4 Surface roughness**. Roughness of the surface facilitates transition.
- 5 Contamination**. Dust or bugs on the surface act as roughness.



Airfoil boundary layer at very large Reynolds numbers

Aerodynamics

R. Tognaccini

Introduction

Hydrostatics

Fundamental principles

Incompressible inviscid flow

Effects of viscosity

Effects of compressibility

Aircraft lift-drag polar

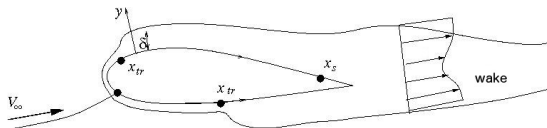

- 1 Two boundary layers develop on the upper and lower sides, starting from front stagnation point. Initial boundary layer thickness is not zero.
- 2 Initially the boundary layer is laminar.
- 3 (Possible) laminar separation. When separated the flow quickly becomes turbulent, acquires energy and reattaches (laminar separation bubble).
- 4 Transition to turbulence.
- 5 (Possible) turbulent separation.
- 6 Airfoil wake.



Airfoil drag in subsonic flow

Aerodynamics

R. Tognaccini

Introduction

Hydrostatics

Fundamental principles

Incompressible inviscid flow

Effects of viscosity

Effects of compressibility

Aircraft lift-drag polar

- In subsonic flow airfoil drag (2d flow) is completely of viscous origin and is named **profile drag** (d_p).
- Profile drag is built-up of two contributions:
 - 1 friction drag (d_f), due to the direct action of friction stresses on the airfoil surface in both laminar and turbulent region.
 - 2 form or wake drag (d_{wake}), due to the not complete recover of pressure in the aft part of the airfoil.

Profile drag decomposition

$$d_p = d_f + d_{wake}$$



The wake drag

Aerodynamics

R. Tognaccini

Introduction

Hydrostatics

Fundamental principles

Incompressible inviscid flow

Effects of viscosity

Effects of compressibility

Aircraft lift-drag polar

- Due to the difference between the actual pressure distribution on the airfoil and the one in theoretical inviscid condition.
- In real viscous flow, stagnation pressure is not recovered at the trailing edge implying loss of the thrust force present in the back of the airfoil.
- It is always present but very significant when separation occurs.
- For *aerodynamic* bodies friction drag is dominant.
- For *blunt* bodies wake drag is dominant.
- Flat plate at $0deg$ and $90deg$ AoA: $C_{d90} \approx 100C_{d0}$. At $90deg$ flow separates at plate tips. $C_p \approx 1$ on the front plate whereas, $C_p \approx 0$ on the back.



The drag on a circular cylinder

The drag "crisis" of cylinders and spheres

Aerodynamics

R. Tognaccini

Introduction

Hydrostatics

Fundamental principles

Incompressible inviscid flow

Effects of viscosity

Effects of compressibility

Aircraft lift-drag polar

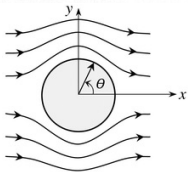
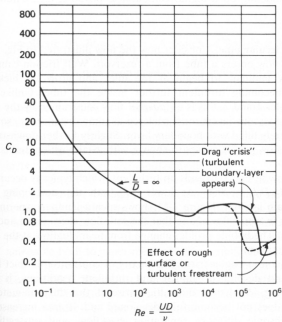

- Up to $Re_D \approx 10^3$, drag is essentially friction: it reduces as Re_D grows.
- For $Re_D > 10^3$, drag is mostly wake drag, therefore independent of Re_D .
- At $Re_D \approx 10^5$ separation moves from laminar to turbulent.
- In the case of laminar flow, separation at $\theta = 100deg$.
- In the case of turbulent flow, separation at $\theta = 80deg$.
- When separation at $\theta = 80deg$, improved pressure recovery in the back: very significant reduction of wake drag.
- Roughness enhances turbulence and anticipates drag "crisis" (the golf ball).



The laminar airfoils

Aerodynamics

R. Tognaccini

Introduction

Hydrostatics

Fundamental
principles

Incompressible
inviscid flow

Effects of
viscosity

Effects of
compressibility

Aircraft
lift-drag polar

- Airfoil drag can be effectively reduced by increasing the extent of the laminar region.
- **Laminar airfoils** are characterized by a very large extension of the laminar region starting from stagnation point near the leading edge.
- This objective is obtained moving back the point where the pressure gradient becomes adverse ($dp/dx > 0$).
- This result can be obtained, for instance, in a limited range of angles of attack, moving back the position of maximum thickness.
- Laminar airfoils were independently introduced during WWII, by USA and Japan.



NACA 6th-series laminar airfoils

Aerodynamics

R. Tognaccini

Introduction

Hydrostatics

Fundamental principles

Incompressible inviscid flow

Effects of viscosity

Effects of compressibility

Aircraft lift-drag polar

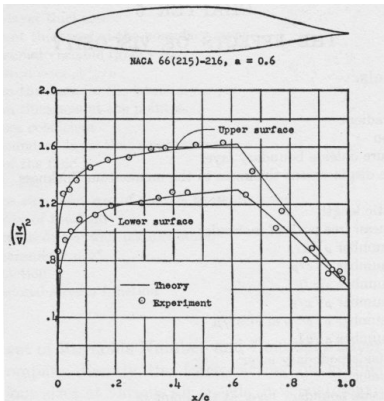

Numbering system example:
NACA 65-215 $a=0.6$

- 6: series number;
- 5: laminar region up to $x/c \approx 0.5$;
- 2: ideal lift coefficient $C_{l_i} = 0.2$;
- 15: thickness = 0.15%
- $a=0.6$: type of mean line.



Laminar airfoil performance (1/2)

in ipersonic flow

Aerodynamics

R. Tognaccini

Introduction

Hydrostatics

Fundamental principles

Incompressible inviscid flow

Effects of viscosity

Effects of compressibility

Aircraft lift-drag polar

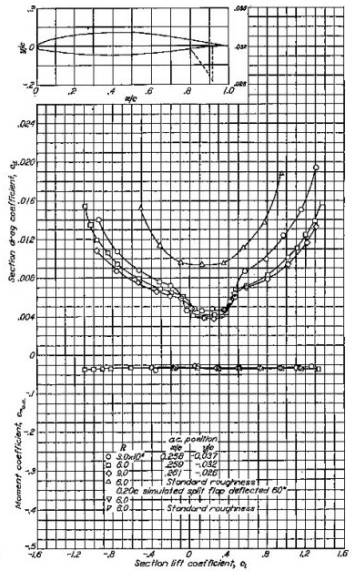
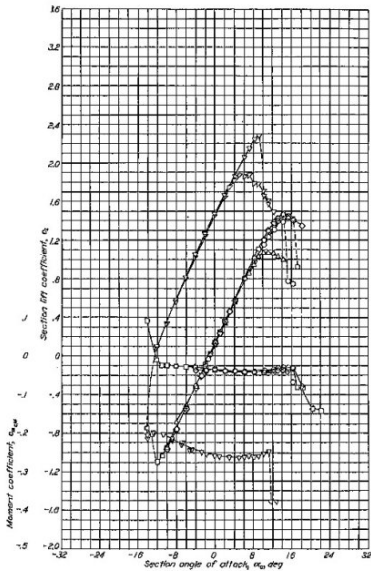

Aerodynamic characteristics of the NACA 651-212 airfoil section, 94-both charts.

NACA 651-212



Laminar airfoil performance (2/2)

in iposonic flow

Aerodynamics

R. Tognaccini

Introduction

Hydrostatics

Fundamental principles

Incompressible inviscid flow

Effects of viscosity

Effects of compressibility

Aircraft lift-drag polar

- Lift-drag polar curve is characterized by the typical **laminar “bag”** around the **ideal** lift coefficient (C_{l_i}), where the drag coefficient is significantly lower.
- Up to 30% reduction of profile drag in cruise conditions.
- Far from C_{l_i} , due to the appearance of the pressure peak and consequent strong adverse pressure gradient, the laminar bag disappears and drag is again comparable to standard airfoils.
- High lift performance worse than standard airfoils.
- Due to contamination and surface roughness, laminar flow conditions are very difficult to obtain in flight.
- Laminar airfoils were a success but not for obtaining laminar flow. . .



3D boundary layers

Aerodynamics

R. Tognaccini

Introduction

Hydrostatics

Fundamental principles

Incompressible inviscid flow

Effects of viscosity

Effects of compressibility

Aircraft lift-drag polar

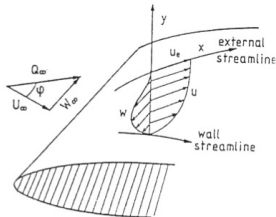

Velocity profile in a 3d boundary layer

- On a swept wing the inviscid streamline on the wing is curved.
- Centrifugal force is balanced by pressure gradient.
- Pressure gradient remains constant inside boundary layer, but centrifugal force diminishes ($\underline{V} \rightarrow 0$), implying the rise of a crossflow velocity (w).
- w profile has always an inflection: **boundary layers on swept wings are unstable**: impossible to obtain a *natural* extended laminar region.



Airfoil stall in ipersonic flow.

Aerodynamics

R. Tognaccini

Introduction

Hydrostatics

Fundamental
principles

Incompressible
inviscid flow

Effects of
viscosity

Effects of
compressibility

Aircraft
lift-drag polar

- The airfoil stall is an essentially viscous phenomenon.
- $C_{l_{max}}$ and stall angle α_s increases as R_∞ increases.
- Stall types:
 - 1 **Turbulent stall** for trailing edge separation, typical of thick airfoils ($t > 12\%$). A separation point x_s appears at trailing edge on the upper side. It moves forward as α increases. Stall occurs when $x_s/c \approx 0.5$. It is a *smooth* stall.
 - 2 **Burst of laminar separation bubble (LSB)**. Typical of medium thickness airfoils and/or lower Reynolds number flows ($Re_\infty < 10^6$). The LSB appears on the upper side; this stall is an *abrupt* and dangerous phenomenon.
 - 3 **Long bubble stall**, typical of thin airfoils. A LSB appears, it increases in size with α ; stall occurs when the LSB covers most of the upper airfoil.
 - 4 **Combined stall**. Contemporary 1 and 2 phenomena.



Wing stall

Aerodynamics

R. Tognaccini

Introduction

Hydrostatics

Fundamental principles

Incompressible inviscid flow

Effects of viscosity

Effects of compressibility

Aircraft lift-drag polar

- Wing stall is a complex unsteady and strongly 3D phenomenon.
- Usually it is not symmetrical: it appears on one of the wings first.
- Therefore it is mandatory to have aircraft control on the roll axis: central part of the wing should stall first (ailerons must be still effective).
- An *approximate* stall path can be determined by the analysis of the curve $C_{l_{max}}(\eta) - C_{l_b}(\eta)$ assuming (false) the airfoils behave in 2d up to stall and beyond.



Summary of airfoil performance

Effects of the different parameters (iposonic flow)

Aerodynamics

R. Tognaccini

Introduction

Hydrostatics

Fundamental principles

Incompressible inviscid flow

Effects of viscosity

Effects of compressibility

Aircraft lift-drag polar

- $C_l \approx C_{l_\alpha}(\alpha - \alpha_{zl})$.
- $C_{l_\alpha} \approx 2\pi$ and (weakly) increases with thickness.
- $|\alpha_{zl}|$ linearly increases with curvature.
- $C_{d_{min}}$ at $\alpha = \alpha_i$ (ideal AoA), $C_{d_{min}} \approx 90dc$, (thick airfoils), $Re_\infty > 10^6$, fully turbulent flow.
- $C_{l_{max}}$ and α_s increases with Re_∞ . $C_{l_{max}} \approx 1.6$ and $\alpha_s \approx 15deg$ (thick airfoils), $Re_\infty > 10^6$.
- Stall type mainly influenced by Re_∞ and thickness.



High-lift devices

Aerodynamics

R. Tognaccini

Introduction

Hydrostatics

Fundamental principles

Incompressible inviscid flow

Effects of viscosity

Effects of compressibility

Aircraft lift-drag polar

The task of a high-lift device is to increase $C_{L_{max}}$ and reduce stall speed.

- 1 Mechanical systems.
- 2 Boundary layer control systems.
- 3 Jet-flaps.

Here we just briefly discuss the most adopted solution:
mechanical systems.



Flaps

Aerodynamics

R. Tognaccini

Introduction

Hydrostatics

Fundamental principles

Incompressible inviscid flow

Effects of viscosity

Effects of compressibility

Aircraft lift-drag polar

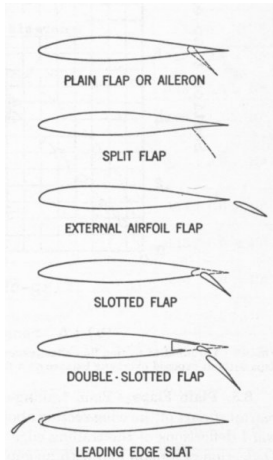

Simple flap

- Flap rotation allows for a curvature variation. $\delta_{flap} > 0 \Rightarrow |\alpha_{zl}|$ increase.
- $\delta_{flap} > 0 \Rightarrow$ increase of C_l at fixed AoA.
- Stall angle decreases for $\delta_{flap} > 0$, but usually $C_{l,max}$ increases.

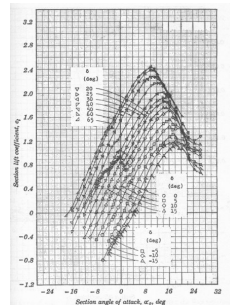



Slotted flap and Fowler flap

Aerodynamics

R. Tognaccini

Introduction

Hydrostatics

Fundamental principles

Incompressible inviscid flow

Effects of viscosity

Effects of compressibility

Aircraft lift-drag polar

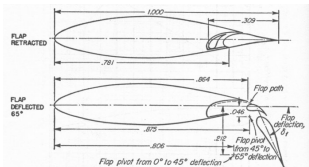

Double slotted flap

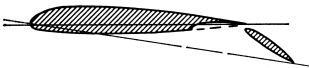

Fowler flap

Device type	$\Delta C_{l_{max}}$
Simple flap	≈ 0.9
Slotted flap	≈ 1.5
Double slotted flap	≈ 1.9
Fowler flap	≈ 1.5

Slotted flap

- High pressure, high energy air on lower side airfoil moves through the slot on the upper side.
- Separation considerably delayed.
- Stall angle α_s increases, consequent increase of $C_{L_{max}}$.

Fowler flap

- Main result: increase of wing surface.
- Secondary action: increase of curvature.
- It can also be slotted.



Slat

Aerodynamics

R. Tognaccini

Introduction

Hydrostatics

Fundamental principles

Incompressible inviscid flow

Effects of viscosity

Effects of compressibility

Aircraft lift-drag polar

The slat is a small wing positioned in front of the main body.

- The slot energizes the upper side.
- Pressure peak on the slat: weaker adverse pressure gradient on the main body.
- $\Delta C_{l_{max}} \approx 0.5$.

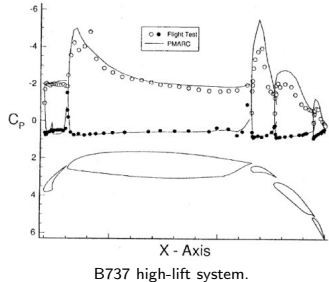



Boundary layer around a flapped airfoil

Aerodynamics

R. Tognaccini

Introduction

Hydrostatics

Fundamental principles

Incompressible inviscid flow

Effects of viscosity

Effects of compressibility

Aircraft lift-drag polar

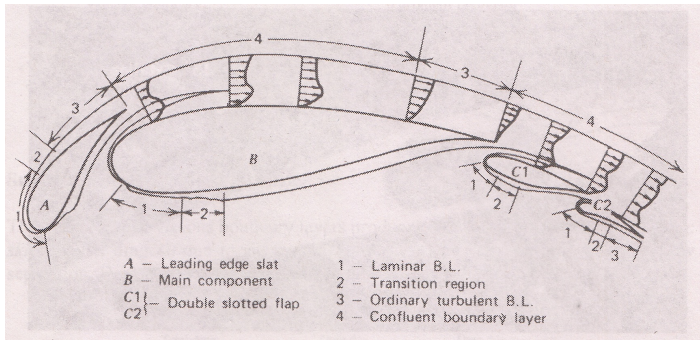



Sound wave propagation in a compressible inviscid flow

Aerodynamics

R. Tognaccini

Introduction

Hydrostatics

Fundamental
principles

Incompressible
inviscid flow

Effects of
viscosity

Effects of
compressibility

Aircraft
lift-drag polar

- $a^2 = \frac{d\rho}{d\rho} = \lim_{\Delta\rho \rightarrow 0} \frac{\Delta\rho}{\Delta\rho}$.
- Incompressible flow: $\Delta\rho \rightarrow 0 \Rightarrow a^2 \rightarrow \infty$
- In an incompressible flow pressure perturbations propagate at infinite speed: **the presence of the body in an uniform stream is simultaneous felt in the complete infinite domain.**
- In a compressible flow pressure perturbations propagate at a finite speed: **the space travelled by a pressure perturbation during time t is finite and is $s = at$.**



Sound wave propagation in supersonic flow

Aerodynamics

R. Tognaccini

Introduction

Hydrostatics

Fundamental principles

Incompressible inviscid flow

Effects of viscosity

Effects of compressibility

Aircraft lift-drag polar

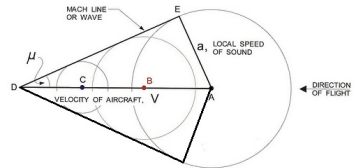
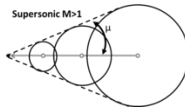
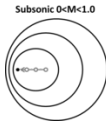

$$\mu = \arcsin \frac{a}{V} = \arcsin \frac{1}{M} \quad (90)$$

μ : Mach angle.

- In supersonic flow pressure perturbations in the motion of the point from A to D are only felt in the region between the two Mach waves starting from point D.
- Flow perturbations travel on Mach waves.
- Along a Mach wave, fluid properties are constant.
- Outside the Mach cone flow perturbations (also sound) are not felt.



Supersonic flow around an infinitesimal wedge

Aerodynamics

R. Tognaccini

Introduction

Hydrostatics

Fundamental principles

Incompressible inviscid flow

Effects of viscosity

Effects of compressibility

Aircraft lift-drag polar

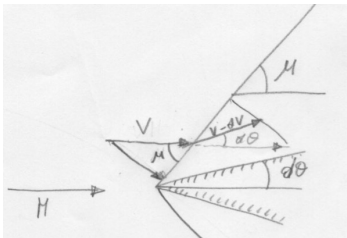

- Just one perturbation in the flow at the wedge, where a Mach wave starts.
- Downstream of the Mach wave the flow deviates of an angle $d\theta$.
- $p = \text{const}$ along the Mach wave: from momentum equation (35) $V \cos \mu = \text{const}$.

$$V \cos \mu = (V + dV) \cos(\mu - d\theta) \quad (91)$$

Since $d\theta \ll 1$ and neglecting 2nd order term $\sin \mu dV d\theta$:

$$V \sin \mu d\theta + \cos \mu dV = 0 \quad (92)$$

$$\frac{dV}{V} = -\frac{d\theta}{\sqrt{M^2 - 1}} \quad (93)$$

From momentum equation:

$$\frac{dp}{\rho V^2} = \frac{d\theta}{\sqrt{M^2 - 1}} \quad (94)$$



Supersonic flow around an infinitesimal expansion corner

Aerodynamics

R. Tognaccini

Introduction

Hydrostatics

Fundamental principles

Incompressible inviscid flow

Effects of viscosity

Effects of compressibility

Aircraft lift-drag polar

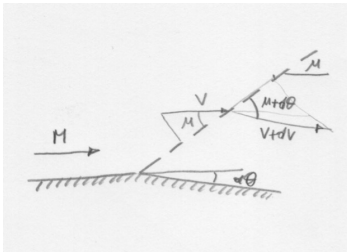

- Just one perturbation in the flow at the corner, where a Mach wave starts.
- Downstream of the Mach wave the flow deviates of $d\theta$.

As for the infinitesimal wedge:

$$V \cos \mu = (V + dV) \cos(\mu + d\theta) \quad (95)$$

$$-V \sin \mu d\theta + \cos \mu dV = 0 \quad (96)$$

$$\frac{dV}{V} = \frac{d\theta}{\sqrt{M^2 - 1}} \quad (97)$$

$$\frac{dp}{\rho V^2} = -\frac{d\theta}{\sqrt{M^2 - 1}} \quad (98)$$



Supersonic flow around a flat plate at $\alpha \ll 1$

Ackeret linearized theory

Aerodynamics

R. Tognaccini

Introduction

Hydrostatics

Fundamental principles

Incompressible inviscid flow

Effects of viscosity

Effects of compressibility

Aircraft lift-drag polar

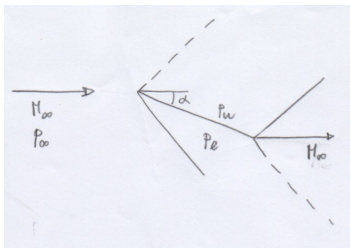

Solid lines: compression wave:
 $dV < 0, dp > 0$.

Dashed lines: expansion wave:
 $dV > 0, dp < 0$.

Lift: $l = (p_l - p_u)c$

Drag: $d = (p_l - p_u)c\alpha$.

$$\frac{p_l - p_\infty}{\rho V_\infty^2} = \frac{\alpha}{\sqrt{M_\infty^2 - 1}} \quad (99)$$

$$\frac{p_u - p_\infty}{\rho V_\infty^2} = -\frac{\alpha}{\sqrt{M_\infty^2 - 1}} \quad (100)$$

Lift coefficient:

$$C_l = \frac{4\alpha}{\sqrt{M_\infty^2 - 1}} \quad (101)$$

Wave drag coefficient:

$$C_{d_w} = \frac{4\alpha^2}{\sqrt{M_\infty^2 - 1}} \quad (102)$$



Performance of supersonic flat plate airfoil

Ackeret linearized theory

Aerodynamics

R. Tognaccini

Introduction

Hydrostatics

Fundamental principles

Incompressible inviscid flow

Effects of viscosity

Effects of compressibility

Aircraft lift-drag polar

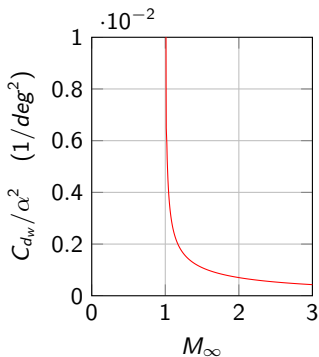
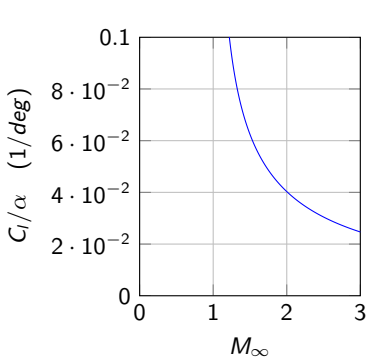

- Pressure is constant along the upper and lower plate (not so in subsonic flow).
- Pressure centre: $x_{cp}/c = 0.5$ moves backward with respect to subsonic flow ($x_{cp}/c = 0.25$).
- $C_{m_{je}} = -C_l/2$.



Supersonic, thin and cambered airfoil

Ackeret linearized theory

Aerodynamics

R. Tognaccini

Introduction

Hydrostatics

Fundamental principles

Incompressible inviscid flow

Effects of viscosity

Effects of compressibility

Aircraft lift-drag polar

Airfoil geometry: $y = \gamma C(x) \pm \tau T(x)$

$\gamma = y_{max}/c$ of mean line (curvature);

$\tau =$ airfoil maximum thickness (percentage).

$$1 \quad C_l = \frac{4\alpha}{\sqrt{M_\infty^2 - 1}}$$

$$2 \quad C_{d_w} = \frac{4}{\sqrt{M_\infty^2 - 1}} \left[\alpha^2 + \frac{\gamma^2}{c} \int_0^c C'^2(x) dx + \frac{\tau^2}{c} \int_0^c T'^2(x) dx \right]$$

$$3 \quad C_{m_{le}} = -\frac{C_l}{2}, \quad \frac{x_{cp}}{c} = 0.5$$

- Lift not influenced by both curvature and thickness. . .
- . . . but curvature and thickness add considerable wave drag.
- A **supersonic** airfoil is symmetric and thin with a **sharp** leading edge.
- Curvature variation cannot be used for lift control: ailerons and flaps are not effective for supersonic airfoils.



Shock waves

Aerodynamics

R. Tognaccini

Introduction

Hydrostatics

Fundamental
principles

Incompressible
inviscid flow

Effects of
viscosity

Effects of
compressibility

Aircraft
lift-drag polar

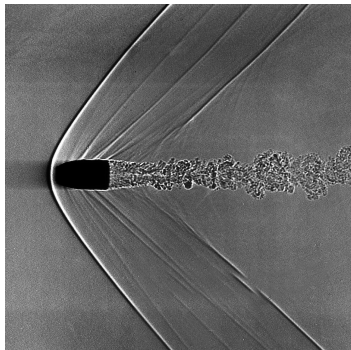

- **Small** pressure perturbations travel at the speed of sound.
- **Strong** pressure perturbations can travel faster: the **shock waves**.

A shock wave is an extremely thin region ($\approx 10^{-5} \text{ cm}$) across which fluid properties change drastically.



Normal shock waves

Aerodynamics

R. Tognaccini

Introduction

Hydrostatics

Fundamental principles

Incompressible inviscid flow

Effects of viscosity

Effects of compressibility

Aircraft lift-drag polar

Across a shock wave the flow variables are **discontinuous**.

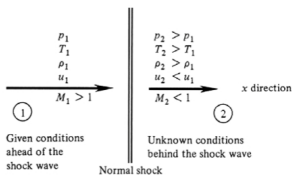

Governing equations

- 1 Continuity: $\rho_1 u_1 = \rho_2 u_2$
- 2 Momentum: $p_1 + \rho_1 u_1^2 = p_2 + \rho_2 u_2^2$
- 3 Energy: $h_1 + \frac{u_1^2}{2} = h_2 + \frac{u_2^2}{2}$

Solution:

- 1 $M_2^2 = \frac{1 + [(\gamma - 1)/2]M_1^2}{\gamma M_1^2 - (\gamma - 1)/2}$
- 2 $\frac{\rho_2}{\rho_1} = \frac{u_1}{u_2} = \frac{(\gamma + 1)M_1^2}{2 + (\gamma - 1)M_1^2}$
- 3 $\frac{p_2}{p_1} = 1 + \frac{2\gamma}{\gamma + 1}(M_1^2 - 1)$

$\gamma = \frac{c_p}{c_v}$: specific heat ratio
(1.4 for air).

- Large **positive** pressure jump across a shock wave.
- The flow downstream of a **normal** shock wave is **subsonic**.
- Downstream flow only depends on upstream Mach number M_1 .



Oblique shock waves and expansion fans

Aerodynamics

R. Tognaccini

Introduction

Hydrostatics

Fundamental principles

Incompressible inviscid flow

Effects of viscosity

Effects of compressibility

Aircraft lift-drag polar

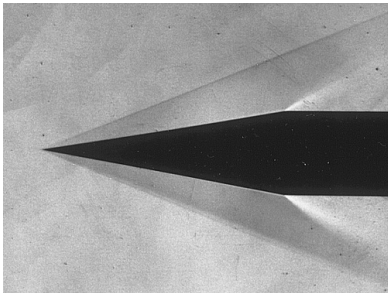
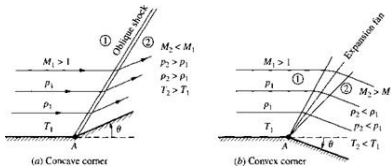

- Mach waves only allow for very small deviations θ .
- What happens for larger θ ?
- Case (b): Mach waves inclination μ reduces while flow expands (velocity increases) through an **expansion fan**.
- The flow across an expansion fan is continuous.
- Case (a): on the contrary, there is a coalescence of compression waves into a single **oblique shock wave**.
- Across the oblique shock wave the flow is discontinuous.



Oblique shock wave chart

Aerodynamics

R. Tognaccini

Introduction

Hydrostatics

Fundamental principles

Incompressible inviscid flow

Effects of viscosity

Effects of compressibility

Aircraft lift-drag polar

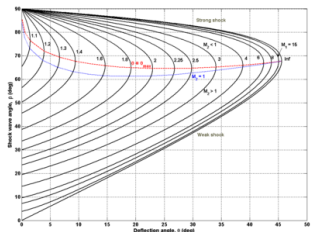
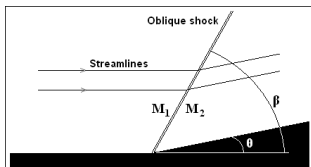

- For each M_1 there is a θ_{max} .
- If $\theta > \theta_{max}$ it is necessary the presence of a normal shock (at least locally).
- Given M_1 and θ , two obliques shocks are possible: a **strong shock** and a **weak shock**.
- Strong or weak depends on the boundary conditions.
- Usually there are weak shocks around isolated airfoils and wings.
- Downstream of a strong shock the flow is subsonic.
- Except for the small region between red and blue curves, downstream of a weak shock the flow is supersonic.



Procedure for oblique shock wave calculation

Aerodynamics

R. Tognaccini

Introduction

Hydrostatics

Fundamental principles

Incompressible inviscid flow

Effects of viscosity

Effects of compressibility

Aircraft lift-drag polar

- 1 Assign upstream Mach number M_1 and deflection angle θ .
- 2 Enter in oblique shock wave chart with M_1 and θ and find shock wave angle β .
- 3 Compute upstream Mach number normal to shock wave:
$$M_{n1} = M_1 \sin \beta.$$
- 4 Compute downstream Mach number normal to shock wave M_{n2} , ρ_2/ρ_1 and p_2/p_1 by normal shock wave relations or tables. T_2/T_1 can be obtained by perfect gas state equation.
- 5 Compute downstream Mach number:
$$M_2 = M_{n2} / \sin(\beta - \theta).$$



Prandtl-Meyer expansion waves

Aerodynamics

R. Tognaccini

Introduction

Hydrostatics

Fundamental principles

Incompressible inviscid flow

Effects of viscosity

Effects of compressibility

Aircraft lift-drag polar

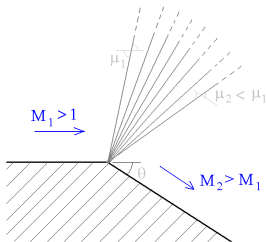

Prandtl-Meyer function

$$\nu(M) = \sqrt{\frac{\gamma+1}{\gamma-1}} \arctan \sqrt{\frac{\gamma-1}{\gamma+1}} (M^2 - 1) - \arctan \sqrt{M^2 - 1} \quad (103)$$

$$\theta = \nu(M_2) - \nu(M_1) \quad (104)$$

Computation of the expansion fan, given M_1 and θ

- 1 Compute $\nu(M_1)$ from eq. (103).
- 2 Compute $\nu(M_2)$ from eq. (104).
- 3 Compute $\nu(M_2)$ from eq. (103).
- 4 In the expansion fan, flow is isentropic; p , ρ and T can be computed from eqs. (45) and (46).

Procedure simplified by table in the next slide.



Prandtl-Meyer function and Mach angle

Table for Mach range [1, 5]

Aerodynamics
R. Tognaccini

- Introduction
- Hydrostatics
- Fundamental principles
- Incompressible inviscid flow
- Effects of viscosity
- Effects of compressibility
- Aircraft lift-drag polar

Table A.5 | Prandtl-Meyer function and Mach angle

M	ν	μ	M	ν	μ
0.1000 + 01	0.0000	0.9000 + 02	0.3000 + 01	0.2638 + 02	0.3000 + 02
0.1020 + 01	0.1257 + 00	0.1064 + 02	0.2050 + 01	0.2778 + 02	0.2920 + 02
0.1040 + 01	0.3010 + 00	0.1046 + 02	0.2100 + 01	0.2910 + 02	0.2844 + 02
0.1060 + 01	0.6367 + 00	0.1063 + 02	0.2150 + 01	0.3043 + 02	0.2772 + 02
0.1080 + 01	0.9601 + 00	0.1081 + 02	0.2200 + 01	0.3175 + 02	0.2704 + 02
0.1100 + 01	0.1150 + 01	0.1058 + 02	0.2250 + 01	0.3302 + 02	0.2639 + 02
0.1120 + 01	0.1735 + 01	0.1032 + 02	0.2300 + 01	0.3428 + 02	0.2577 + 02
0.1140 + 01	0.2360 + 01	0.1015 + 02	0.2350 + 01	0.3553 + 02	0.2518 + 02
0.1160 + 01	0.2807 + 01	0.1005 + 02	0.2400 + 01	0.3675 + 02	0.2462 + 02
0.1180 + 01	0.3070 + 01	0.1004 + 02	0.2450 + 01	0.3797 + 02	0.2409 + 02
0.1200 + 01	0.3158 + 01	0.1004 + 02	0.2500 + 01	0.3912 + 02	0.2360 + 02
0.1220 + 01	0.4057 + 01	0.1005 + 02	0.2550 + 01	0.4028 + 02	0.2320 + 02
0.1240 + 01	0.4800 + 01	0.1019 + 02	0.2600 + 01	0.4144 + 02	0.2282 + 02
0.1260 + 01	0.5300 + 01	0.1023 + 02	0.2650 + 01	0.4253 + 02	0.2247 + 02
0.1280 + 01	0.5627 + 01	0.1030 + 02	0.2700 + 01	0.4362 + 02	0.2214 + 02
0.1300 + 01	0.6170 + 01	0.1028 + 02	0.2750 + 01	0.4468 + 02	0.2182 + 02
0.1320 + 01	0.6721 + 01	0.1025 + 02	0.2800 + 01	0.4573 + 02	0.2152 + 02
0.1340 + 01	0.7279 + 01	0.1027 + 02	0.2850 + 01	0.4678 + 02	0.2124 + 02
0.1360 + 01	0.7844 + 01	0.1033 + 02	0.2900 + 01	0.4779 + 02	0.2107 + 02
0.1380 + 01	0.8413 + 01	0.1040 + 02	0.2950 + 01	0.4878 + 02	0.1991 + 02
0.1400 + 01	0.8987 + 01	0.1048 + 02	0.3000 + 01	0.4976 + 02	0.1967 + 02
0.1420 + 01	0.9565 + 01	0.1047 + 02	0.3050 + 01	0.5071 + 02	0.1914 + 02
0.1440 + 01	0.1015 + 02	0.1036 + 02	0.3100 + 01	0.5165 + 02	0.1882 + 02
0.1460 + 01	0.1075 + 02	0.1022 + 02	0.3150 + 01	0.5257 + 02	0.1851 + 02
0.1480 + 01	0.1132 + 02	0.1025 + 02	0.3200 + 01	0.5347 + 02	0.1821 + 02
0.1500 + 01	0.1191 + 02	0.1041 + 02	0.3250 + 01	0.5435 + 02	0.1792 + 02
0.1520 + 01	0.1250 + 02	0.1034 + 02	0.3300 + 01	0.5522 + 02	0.1764 + 02
0.1540 + 01	0.1309 + 02	0.1049 + 02	0.3350 + 01	0.5607 + 02	0.1737 + 02
0.1560 + 01	0.1368 + 02	0.1087 + 02	0.3400 + 01	0.5691 + 02	0.1710 + 02
0.1580 + 01	0.1427 + 02	0.1087 + 02	0.3450 + 01	0.5773 + 02	0.1684 + 02
0.1600 + 01	0.1487 + 02	0.1080 + 02	0.3500 + 01	0.5854 + 02	0.1658 + 02
0.1620 + 01	0.1548 + 02	0.1052 + 02	0.3550 + 01	0.5932 + 02	0.1634 + 02
0.1640 + 01	0.1608 + 02	0.1077 + 02	0.3600 + 01	0.6009 + 02	0.1612 + 02
0.1660 + 01	0.1669 + 02	0.1070 + 02	0.3650 + 01	0.6085 + 02	0.1590 + 02
0.1680 + 01	0.1732 + 02	0.1063 + 02	0.3700 + 01	0.6160 + 02	0.1569 + 02
0.1700 + 01	0.1793 + 02	0.1067 + 02	0.3750 + 01	0.6233 + 02	0.1549 + 02
0.1720 + 01	0.1840 + 02	0.1055 + 02	0.3800 + 01	0.6304 + 02	0.1529 + 02
0.1740 + 01	0.1888 + 02	0.1058 + 02	0.3850 + 01	0.6373 + 02	0.1509 + 02
0.1760 + 01	0.1938 + 02	0.1062 + 02	0.3900 + 01	0.6441 + 02	0.1489 + 02
0.1780 + 01	0.2003 + 02	0.1048 + 02	0.3950 + 01	0.6512 + 02	0.1469 + 02
0.1800 + 01	0.2073 + 02	0.1075 + 02	0.4000 + 01	0.6578 + 02	0.1449 + 02
0.1820 + 01	0.2131 + 02	0.1033 + 02	0.4050 + 01	0.6642 + 02	0.1429 + 02
0.1840 + 01	0.2188 + 02	0.1029 + 02	0.4100 + 01	0.6708 + 02	0.1412 + 02
0.1860 + 01	0.2235 + 02	0.1025 + 02	0.4150 + 01	0.6772 + 02	0.1395 + 02
0.1880 + 01	0.2280 + 02	0.1021 + 02	0.4200 + 01	0.6833 + 02	0.1377 + 02
0.1900 + 01	0.2323 + 02	0.1016 + 02	0.4250 + 01	0.6894 + 02	0.1361 + 02
0.1920 + 01	0.2415 + 02	0.1019 + 02	0.4300 + 01	0.6954 + 02	0.1345 + 02
0.1940 + 01	0.2471 + 02	0.1020 + 02	0.4350 + 01	0.7013 + 02	0.1329 + 02
0.1960 + 01	0.2527 + 02	0.1006 + 02	0.4400 + 01	0.7070 + 02	0.1313 + 02
0.1980 + 01	0.2583 + 02	0.1003 + 02	0.4450 + 01	0.7127 + 02	0.1298 + 02

Table A.5 | Continued

M	ν	μ	M	ν	μ
0.4500 + 01	0.7183 + 02	0.1280 + 02	0.7400 + 01	0.8297 + 02	0.1700 + 01
0.4550 + 01	0.7228 + 02	0.1276 + 02	0.7500 + 01	0.8364 + 02	0.1662 + 01
0.4600 + 01	0.7270 + 02	0.1270 + 02	0.7600 + 01	0.8430 + 02	0.1624 + 01
0.4650 + 01	0.7313 + 02	0.1262 + 02	0.7700 + 01	0.8494 + 02	0.1586 + 01
0.4700 + 01	0.7357 + 02	0.1255 + 02	0.7800 + 01	0.8558 + 02	0.1548 + 01
0.4750 + 01	0.7400 + 02	0.1247 + 02	0.7900 + 01	0.8621 + 02	0.1512 + 01
0.4800 + 01	0.7444 + 02	0.1240 + 02	0.8000 + 01	0.8682 + 02	0.1476 + 01
0.4850 + 01	0.7488 + 02	0.1232 + 02	0.8100 + 01	0.8742 + 02	0.1440 + 01
0.4900 + 01	0.7532 + 02	0.1224 + 02	0.8200 + 01	0.8800 + 02	0.1404 + 01
0.4950 + 01	0.7576 + 02	0.1216 + 02	0.8300 + 01	0.8857 + 02	0.1368 + 01
0.5000 + 01	0.7620 + 02	0.1208 + 02	0.8400 + 01	0.8913 + 02	0.1332 + 01
0.5050 + 01	0.7664 + 02	0.1200 + 02	0.8500 + 01	0.8968 + 02	0.1296 + 01
0.5100 + 01	0.7708 + 02	0.1192 + 02	0.8600 + 01	0.9022 + 02	0.1260 + 01
0.5150 + 01	0.7752 + 02	0.1184 + 02	0.8700 + 01	0.9075 + 02	0.1224 + 01
0.5200 + 01	0.7796 + 02	0.1176 + 02	0.8800 + 01	0.9127 + 02	0.1188 + 01
0.5250 + 01	0.7840 + 02	0.1168 + 02	0.8900 + 01	0.9179 + 02	0.1152 + 01
0.5300 + 01	0.7884 + 02	0.1160 + 02	0.9000 + 01	0.9230 + 02	0.1116 + 01
0.5350 + 01	0.7928 + 02	0.1152 + 02	0.9100 + 01	0.9280 + 02	0.1080 + 01
0.5400 + 01	0.7972 + 02	0.1144 + 02	0.9200 + 01	0.9329 + 02	0.1044 + 01
0.5450 + 01	0.8016 + 02	0.1136 + 02	0.9300 + 01	0.9378 + 02	0.1008 + 01
0.5500 + 01	0.8060 + 02	0.1128 + 02	0.9400 + 01	0.9426 + 02	0.0972 + 01
0.5550 + 01	0.8104 + 02	0.1120 + 02	0.9500 + 01	0.9474 + 02	0.0936 + 01
0.5600 + 01	0.8148 + 02	0.1112 + 02	0.9600 + 01	0.9521 + 02	0.0900 + 01
0.5650 + 01	0.8192 + 02	0.1104 + 02	0.9700 + 01	0.9568 + 02	0.0864 + 01
0.5700 + 01	0.8236 + 02	0.1096 + 02	0.9800 + 01	0.9614 + 02	0.0828 + 01
0.5750 + 01	0.8280 + 02	0.1088 + 02	0.9900 + 01	0.9660 + 02	0.0792 + 01
0.5800 + 01	0.8324 + 02	0.1080 + 02	1.0000 + 01	0.9706 + 02	0.0756 + 01



Shock-expansion theory

for the analysis of the supersonic airfoil

Aerodynamics

R. Tognaccini

Introduction

Hydrostatics

Fundamental principles

Incompressible inviscid flow

Effects of viscosity

Effects of compressibility

Aircraft lift-drag polar

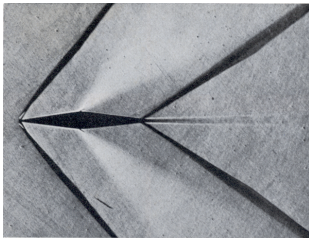

(m) $M_1 = 1.60$

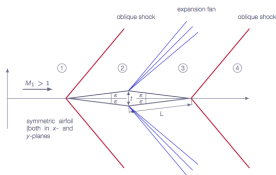

Supersonic airfoil: an airfoil designed with **attached** oblique shocks at leading edge.

- Linearized Ackeret theory can be used to analyze a very thin double wedge airfoil.
- More accurate analysis by **exact** computations of the oblique shocks and expansion fans.
- If $\alpha \neq 0$ and $\alpha > \epsilon$ at leading edge on the upper surface there is an expansion fan!
- Flow in region 4 computed by imposing that pressures downstream of trailing edge coming from lower and upper flows are the same.
- Shock-expansion theory can also be applied to a biconvex airfoil (i.e. circular arc upper and lower surface) subdividing the upper and lower surface in small straight segments.



Practical applications

Aerodynamics

R. Tognaccini

Introduction

Hydrostatics

Fundamental principles

Incompressible inviscid flow

Effects of viscosity

Effects of compressibility

Aircraft lift-drag polar

Problem n. 14

Given M_1 and wedge angle θ , compute the oblique shock.

Problem n. 15

Given M_1 and corner angle θ , compute the expansion fan.

Problem n. 16

Given a double wedge airfoil, $M_\infty > 1$ and α compute the pressure distribution around the airfoil.



The wing of finite \mathcal{R}

The delta wing in supersonic flight

Aerodynamics

R. Tognaccini

Introduction

Hydrostatics

Fundamental principles

Incompressible inviscid flow

Effects of viscosity

Effects of compressibility

Aircraft lift-drag polar

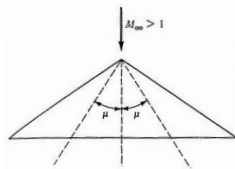

Supersonic leading edge

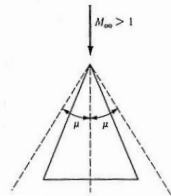

Subsonic leading edge

- Recall that Mach number orthogonal to a Mach wave $M_n = 1$.
- Supersonic LE: the flow orthogonal to the LE is supersonic.
- Subsonic LE: the flow orthogonal to the LE is subsonic.
- Wave drag is considerably lower with a subsonic LE.
- In case of a subsonic LE a conventional **blunt** airfoil can be used implying better wing performance in subsonic flight.



Wing-body performance in supersonic flight

The area rule

Aerodynamics

R. Tognaccini

Introduction

Hydrostatics

Fundamental principles

Incompressible inviscid flow

Effects of viscosity

Effects of compressibility

Aircraft lift-drag polar

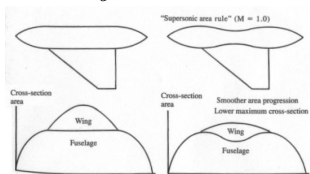
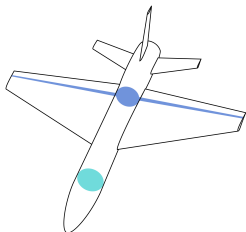

- The wave drag depends on the distribution along the longitudinal x -axis of the frontal area $A(x)$.
- Wave drag is minimized reducing discontinuities of the function $A(x)$.
- Result obtained, for instance, reducing cross section of fuselage where wing starts.

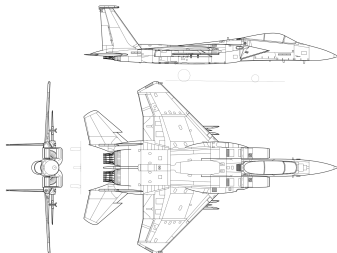

Area rule applied to F-15A



Sonic boom

Aerodynamics

R. Tognaccini

Introduction

Hydrostatics

Fundamental principles

Incompressible inviscid flow

Effects of viscosity

Effects of compressibility

Aircraft lift-drag polar

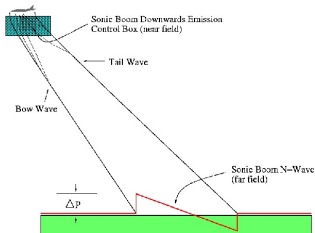

- Sonic boom is given by the trace at sea level of the complex shock-expansion wave patterns produced by the aircraft.
- Due to the interaction of the waves it results on earth in the classical **N-shape** pressure graph.
- Sonic boom is currently limiting the supersonic flight *on land*.
- Future *civil* supersonic flight on land depends on the development of *low-boom* configurations.



Quasi-1d flow

and the subsonic-supersonic nozzle

Aerodynamics

R. Tognaccini

Introduction

Hydrostatics

Fundamental principles

Incompressible inviscid flow

Effects of viscosity

Effects of compressibility

Aircraft lift-drag polar

Continuity + momentum equations:

$$d(\rho VA) = 0 \quad ; \quad dp + \rho V dV = 0 \quad (105)$$

With some calculus ($d\rho/dp = 1/a^2$):

$$\frac{d\rho}{\rho} + \frac{dV}{V} + \frac{dA}{A} = 0 \quad ; \quad \frac{d\rho}{\rho} + M^2 \frac{dV}{V} = 0 \quad (106)$$

Eliminating $d\rho/\rho$ in continuity equation

Area variation against velocity variation:

$$\frac{dA}{A} = -(1 - M^2) \frac{dV}{V} \quad (107)$$

- $M < 1$: $dA > 0 \Rightarrow dV < 0$
- $M > 1$: $dA > 0 \Rightarrow dV > 0$
- $M = 1$: $dA = 0$

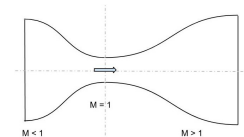



Under-expanded and over-expanded supersonic nozzle

Aerodynamics

R. Tognaccini

Introduction

Hydrostatics

Fundamental principles

Incompressible inviscid flow

Effects of viscosity

Effects of compressibility

Aircraft lift-drag polar

Underexpanded Nozzle

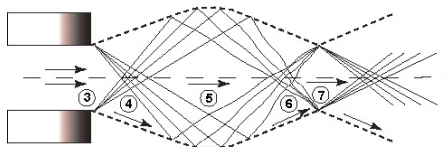

$$P_{exit} > P_{\infty}$$

Overexpanded Nozzle

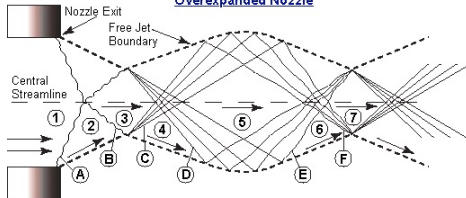

$$P_{exit} < P_{\infty}$$



Subsonic regime

Aerodynamics

R. Tognaccini

Introduction

Hydrostatics

Fundamental principles

Incompressible inviscid flow

Effects of viscosity

Effects of compressibility

Aircraft lift-drag polar

From eq. (107) and momentum equation:

Area variation against pressure variation:

$$\frac{dA}{A} = (1 - M^2) \frac{dp}{\rho V^2} \quad (108)$$

Mach number amplifies pressure variation for a given area variation.

Prandtl-Glauert compressibility rule:

$$C_p(M_\infty) \approx \frac{C_p(M_\infty = 0)}{\sqrt{1 - M_\infty^2}} \quad (109)$$

$$C_l(M_\infty) \approx \frac{C_l(M_\infty = 0)}{\sqrt{1 - M_\infty^2}} \Rightarrow C_{l\alpha}(M_\infty) \approx \frac{C_{l\alpha}(M_\infty = 0)}{\sqrt{1 - M_\infty^2}} \quad (110)$$



Pressure coefficient in compressible regime

Aerodynamics

R. Tognaccini

Introduction

Hydrostatics

Fundamental principles

Incompressible inviscid flow

Effects of viscosity

Effects of compressibility

Aircraft lift-drag polar

Energy equation + isentropic relation + speed of sound formula:

$$\frac{T_0}{T} = 1 + \frac{\gamma-1}{2} M^2; \quad \frac{p_0}{p} = \left(\frac{T_0}{T}\right)^{\gamma/(\gamma-1)}; \quad a^2 = \gamma \frac{p}{\rho}$$

$$\begin{aligned} C_p &= \frac{p - p_\infty}{\frac{1}{2} \rho_\infty V_\infty^2} = \frac{2}{\gamma M_\infty^2} \left(\frac{p}{p_\infty} - 1 \right) \\ &= \frac{2}{\gamma M_\infty^2} \left[\frac{\left(1 + \frac{\gamma-1}{2} M_\infty^2\right)^{\frac{\gamma}{\gamma-1}}}{\left(1 + \frac{\gamma-1}{2} M^2\right)^{\frac{\gamma}{\gamma-1}}} - 1 \right] \end{aligned} \quad (111)$$



Pressure coefficients in stagnation and critical points

Aerodynamics

R. Tognaccini

Introduction

Hydrostatics

Fundamental principles

Incompressible inviscid flow

Effects of viscosity

Effects of compressibility

Aircraft lift-drag polar

Stagnation point ($M = 0$):

$$C_{p0} = \frac{2}{\gamma M_\infty^2} \left[\left(1 + \frac{\gamma - 1}{2} M_\infty^2 \right)^{\frac{\gamma}{\gamma - 1}} - 1 \right] \quad (112)$$

Critical point ($M = 1$):

$$C_p^* = \frac{2}{\gamma M_\infty^2} \left[\left(\frac{\gamma + 1}{2} \right)^{-\frac{\gamma}{\gamma - 1}} \left(1 + \frac{\gamma - 1}{2} M_\infty^2 \right)^{\frac{\gamma}{\gamma - 1}} - 1 \right] \quad (113)$$

- If $M_\infty \neq 0$ then $C_{p0} > 1$.
- If $M_\infty = 1$ then $C_p^* = 0$.



On the lower critical Mach number $M'_{\infty,cr}$ of an airfoil at a given α

Aerodynamics

R. Tognaccini

Introduction

Hydrostatics

Fundamental principles

Incompressible inviscid flow

Effects of viscosity

Effects of compressibility

Aircraft lift-drag polar

- Sonic conditions reached at first in the point of maximum speed, i.e. where $C_p = C_{pmin}$.
- $C_{pmin}(M_\infty)$ given by the Prandtl-Glauert rule eq. (109).

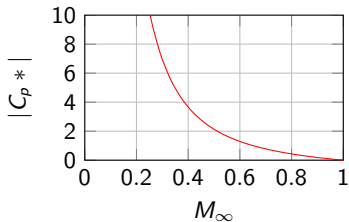
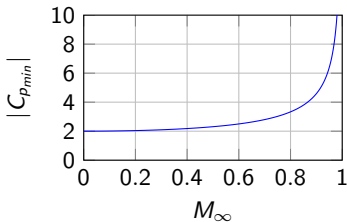

- Abscissa of intersection of $|C_{pmin}|$ with $|C_{p*}|$ gives $M'_{\infty,cr}$.
- $M'_{\infty,cr} = 0.48$ in the picture at right.
- Increasing α implies a reduction of $M'_{\infty,cr}$.

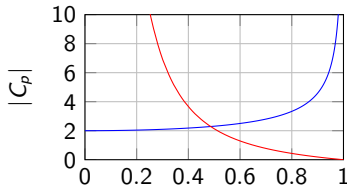



Practical applications

Aerodynamics

R. Tognaccini

Introduction

Hydrostatics

Fundamental principles

Incompressible inviscid flow

Effects of viscosity

Effects of compressibility

Aircraft lift-drag polar

Problem n. 17

Assuming a given pressure peak of the airfoil, compute $M'_{\infty,cr}$.



The transonic regime

$$M'_{\infty,cr} < M_{\infty} < M''_{\infty,cr}$$

Aerodynamics

R. Tognaccini

Introduction

Hydrostatics

Fundamental principles

Incompressible inviscid flow

Effects of viscosity

Effects of compressibility

Aircraft lift-drag polar

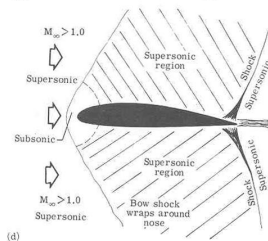
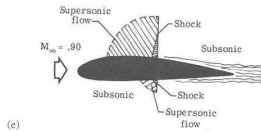
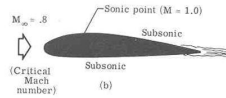
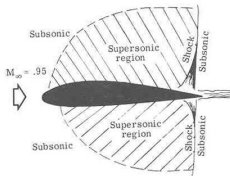
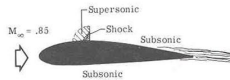
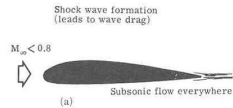



Transonic flow around an airfoil

Aerodynamics

R. Tognaccini

Introduction

Hydrostatics

Fundamental
principles

Incompressible
inviscid flow

Effects of
viscosity

Effects of
compressibility

Aircraft
lift-drag polar

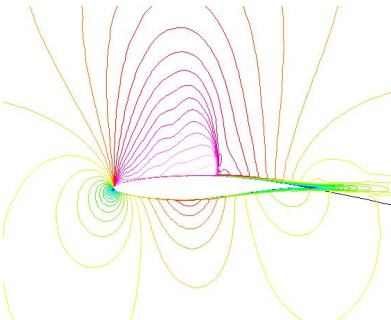

Iso-Mach contours.

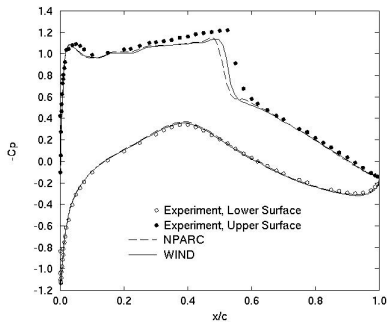

Pressure coefficient on the airfoil.

RAE 2822 airfoil; $\alpha = 2.31\text{deg}$, $M_\infty = 0.729$, $Re_\infty = 6.5 \times 10^6$.



The sonic barrier

Aerodynamics

R. Tognaccini

Introduction

Hydrostatics

Fundamental principles

Incompressible inviscid flow

Effects of viscosity

Effects of compressibility

Aircraft lift-drag polar

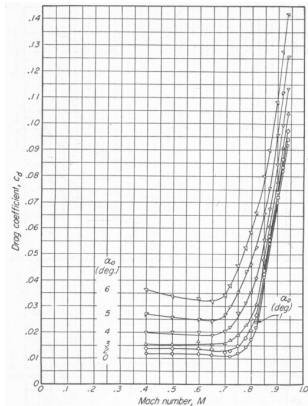

NACA 0012-34; $C_d = C_d(M_\infty)$.

- C_d is approximately constant up to $M'_{\infty,cr}$.
- For $M_\infty > M'_{\infty,cr}$ steep increase of C_d due to wave drag appearance.
- $M_{\infty DD}$, drag divergence Mach number: at $M_\infty = M_{\infty DD}$ we have $dC_d/dM_\infty = 0.1$.
- C_d reaches a maximum value at $M_\infty \approx 1$ then it decreases with the law predicted by Ackeret theory.
- Similarly C_l also reaches a maximum at $M_\infty \approx 1$ and then decreases with the law predicted by Ackeret theory: **shock wave stall**.



Transonic regime peculiarities

Aerodynamics

R. Tognaccini

Introduction

Hydrostatics

Fundamental principles

Incompressible inviscid flow

Effects of viscosity

Effects of compressibility

Aircraft lift-drag polar

- Strong normal shock on the upper surface.
- Important phenomenon of the shock -boundary layer interaction.
- The strong adverse pressure gradient facilitates boundary layer separation.
- Boundary layer thickening, shock advances, boundary layer reattaches, shock draws back, boundary layer separates again and so on: **buffet** phenomenon.
- Too strong stresses on wing in buffet: buffet is the operational limit of commercial aircrafts.
- Ailerons in the separated boundary layer are no more effective.
- Vortex generators on the wing are used to energize the turbulent boundary and so delay the shock induced separation.



The swept wing

Aerodynamics

R. Tognaccini

Introduction

Hydrostatics

Fundamental principles

Incompressible inviscid flow

Effects of viscosity

Effects of compressibility

Aircraft lift-drag polar

At a given AoA, the swept wing increases $M'_{\infty,cr}$, therefore $M_{\infty DD}$ and allows for an increased V_{∞} for a given thrust.

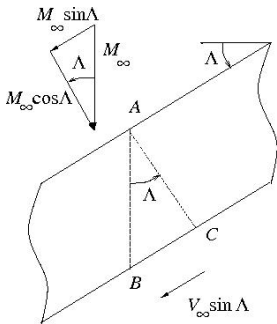

Sketch of an infinite swept wing.

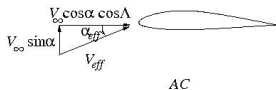
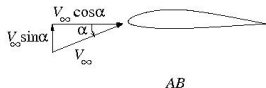

$$\alpha_{eff} \approx \frac{\alpha}{\cos \Lambda} ; \quad (114)$$

$$V_{eff} = \frac{V_{\infty} \cos \Lambda}{\cos \alpha_{eff}} \approx V_{\infty} \cos \Lambda \quad (115)$$



The infinite swept wing

Aerodynamics

R. Tognaccini

Introduction

Hydrostatics

Fundamental principles

Incompressible inviscid flow

Effects of viscosity

Effects of compressibility

Aircraft lift-drag polar

- On an infinite swept wing the cross flow $V_\infty \sin \Lambda$ is not effective.
- The flow around the airfoil AC is 2d with a freestream Mach number $\bar{M}_\infty = M_\infty \cos \Lambda$.
- Being $\bar{M}'_{\infty,cr}$ the critical Mach number of airfoil AC, critical conditions on the wing will be reached when $M_\infty \cos \Lambda = \bar{M}'_{\infty,cr}$.
- Therefore critical Mach number of the wing is $M'_{\infty,cr} = \bar{M}'_{\infty,cr} / \cos \Lambda$
- The critical Mach number has been increased of a factor $1 / \cos \Lambda$!



The lift coefficient of the swept wing 1/2

Aerodynamics

R. Tognaccini

Introduction

Hydrostatics

Fundamental principles

Incompressible inviscid flow

Effects of viscosity

Effects of compressibility

Aircraft lift-drag polar

Total lift can be computed by using both airfoil sections AB and AC:

$$C_l \frac{1}{2} \rho_{\infty} V_{\infty}^2 S = C_{l_{eff}} \frac{1}{2} \rho_{\infty} V_{\infty}^2 S \quad (116)$$

Therefore:

$$C_l V_{\infty}^2 = C_{l_{eff}} V_{eff}^2 \Rightarrow C_l = C_{l_{eff}} \cos^2 \Lambda ; \quad (117)$$

$$C_{l_{eff}} = C_{l_{\alpha}} \alpha_{eff} = C_{l_{\alpha}} \frac{\alpha}{\cos \Lambda} ; \quad (118)$$

$$C_l = C_{l_{\alpha}} \frac{\alpha}{\cos \Lambda} \cos^2 \Lambda = C_{l_{\alpha}} \cos \Lambda \alpha . \quad (119)$$



The lift coefficient of the swept wing 2/2

Aerodynamics

R. Tognaccini

Introduction

Hydrostatics

Fundamental principles

Incompressible inviscid flow

Effects of viscosity

Effects of compressibility

Aircraft lift-drag polar

- The section lift coefficient of a swept wing is a factor $\cos \Lambda$ lower of the corresponding straight wing.
- Low speed performance of a straight wing are better.
- The introduction of a positive Λ on a wing causes a wing load displacement towards the tips.
- On the contrary $\Lambda < 0$ increases the load towards the root section.
- Aeroelastic problems (flutter) currently limit the adoption of negative Λ .
- A positive swept wing usually requires twist and/or taper to obtain a proper wing load distribution.



The airfoil for transonic wings

Aerodynamics

R. Tognaccini

Introduction

Hydrostatics

Fundamental principles

Incompressible inviscid flow

Effects of viscosity

Effects of compressibility

Aircraft lift-drag polar

- To obtain an increase of $M'_{\infty,cr}$ and therefore of $M_{\infty DD}$ necessary to reduce pressure peak.
- Laminar airfoils better suited than standard airfoils, but with a cruise $M_{\infty} < M'_{\infty,cr}$.
- Supercritical airfoils are designed for a cruise $M_{\infty} > M'_{\infty,cr}$.
- Blunt LE and flatter upper surface allows for a reduced maximum M : therefore weaker shock.
- Necessary lift recovery by rear camber.

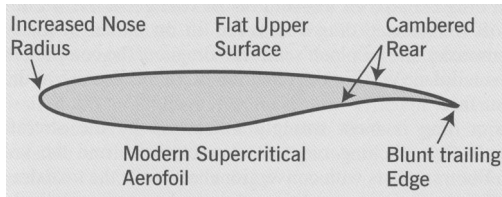



Supercritical vs conventional airfoil

Aerodynamics

R. Tognaccini

Introduction

Hydrostatics

Fundamental principles

Incompressible inviscid flow

Effects of viscosity

Effects of compressibility

Aircraft lift-drag polar

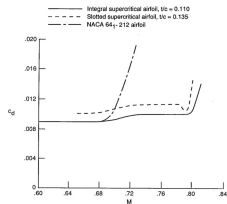
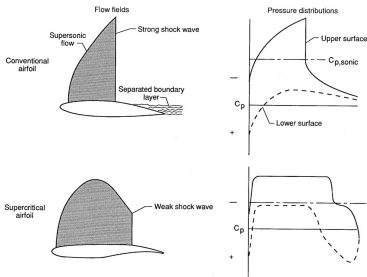

Variation of section drag coefficient with Mach number for section normal-force coefficient of 0.65.



Aircraft lift-drag polar

Aerodynamics

R. Tognaccini

Introduction

Hydrostatics

Fundamental principles

Incompressible inviscid flow

Effects of viscosity

Effects of compressibility

Aircraft lift-drag polar

$$C_L = C_L(C_D, Re_\infty, M_\infty, \text{configuration, trim, engine}) \quad (120)$$

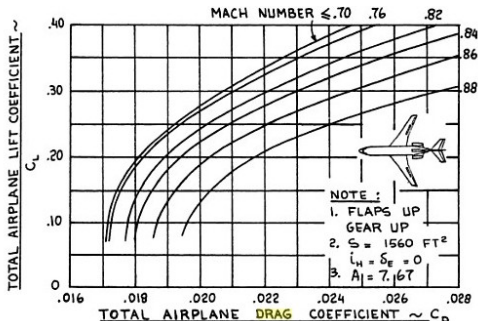

Preliminary design polar in cruise:

$$C_D = C_{D0} + \frac{C_L^2}{\pi Re} \quad (121)$$



Remarks

on the parabolic approximation of the aircraft polar

Aerodynamics

R. Tognaccini

Introduction

Hydrostatics

Fundamental principles

Incompressible inviscid flow

Effects of viscosity

Effects of compressibility

Aircraft lift-drag polar

- C_{D0} takes into account for profile and wave drag.
- The quadratic term essentially takes into account for the lift induced drag.
- The parabolic approximation cannot clearly be used in high lift condition: **it cannot reproduce stall!**
- Minimum Drag is in general not obtained for $C_L = 0$.
- Profile and wave drag depend on C_L : it can be taken into account by a proper modification of the parameter e .



Calculation of C_{D0}

Aerodynamics

R. Tognaccini

Introduction

Hydrostatics

Fundamental principles

Incompressible inviscid flow

Effects of viscosity

Effects of compressibility

Aircraft lift-drag polar

Aircraft is subdivided in N components: wing, fuselage, nacelle, horizontal tail, ...

$$C_{D0} = \frac{1}{S} \sum_{k=1}^N IF_k C_{D_k} S_k \quad (122)$$

C_{D_k} : drag coefficient of component k .

S_k : reference surface of component k .

IF_k : interference factor of the component k with the rest of the configuration.

If component k is an *aerodynamic* body, the profile drag of the airfoil is essentially friction:

$$C_{D_k} = \bar{C}_f \frac{S_{wet}}{S} FF_k \quad (123)$$

\bar{C}_f : flat plate average drag coefficient.

S_{wet} : **wetted** area of the component k .

FF_k : form factor of the component k .



Practical applications

Aerodynamics

R. Tognaccini

Introduction

Hydrostatics

Fundamental principles

Incompressible inviscid flow

Effects of viscosity

Effects of compressibility

Aircraft lift-drag polar

Problem n. 18

Compute the profile drag coefficient of a tapered wing.

$$C_{D_p} = \frac{1}{S} \int_{-b/2}^{+b/2} C_{d_p} c dy \quad (124)$$

C_{d_p} : profile drag coefficient of the airfoil.